



FRZ series

Air Filter

Oil Mist Filter

Micro Oil Mist Filter

Down sizing

Visible filter element

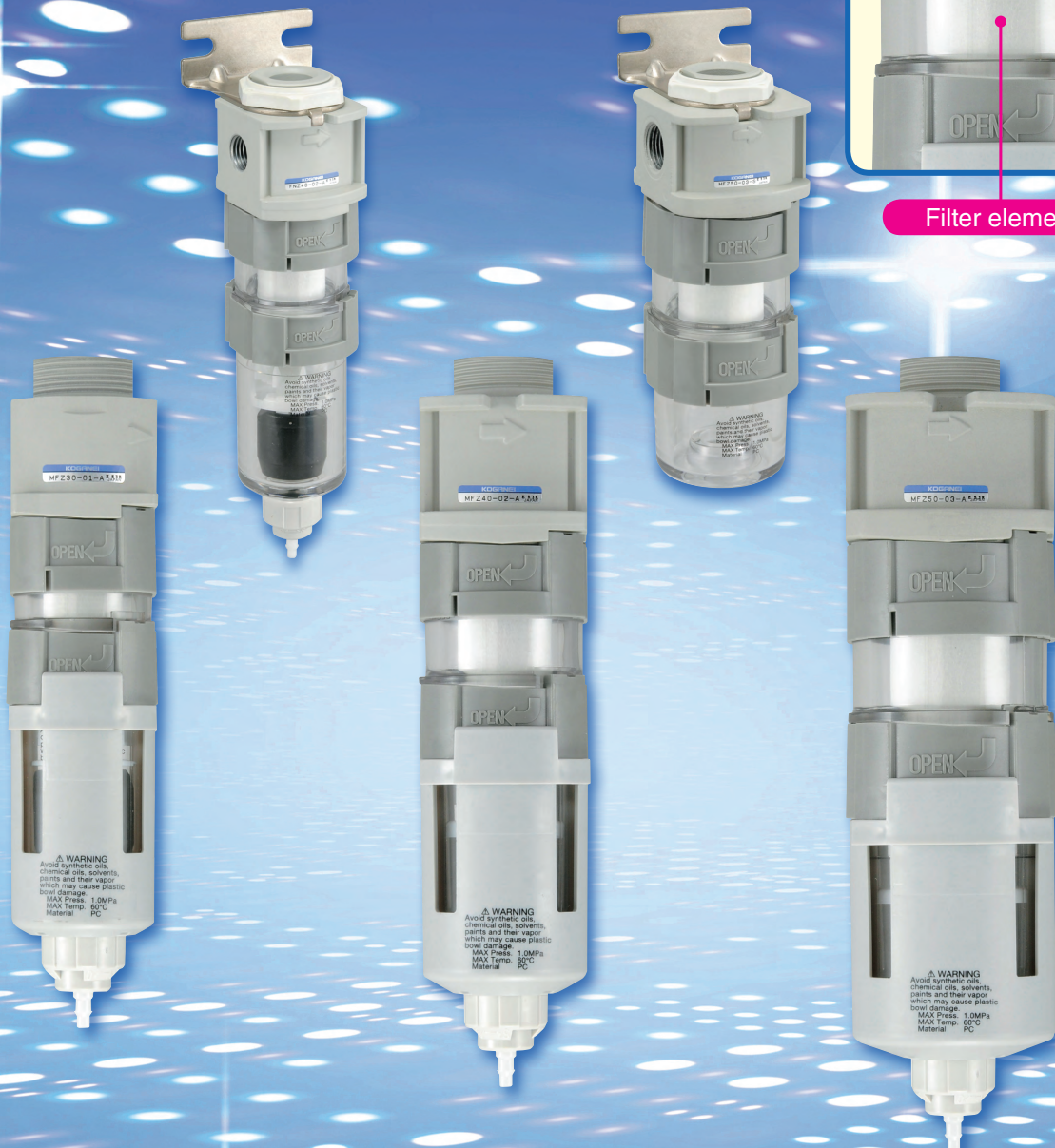

FRZ series

Air Filter, Oil Mist Filter, and Micro Oil Mist Filter

Specialized **30 series** for standalone applications

35 [1.378]



Air filter
FNZ30



Oil mist filter
MFZ30



Micro oil mist filter
MMFZ30

The **40 and 50 series** can be used in combination with others in the FRZ series

40 [1.575]



Air filter
FNZ40



Oil mist filter
MFZ40



Micro oil mist filter
MMFZ40

50 [1.969]



Air filter
FNZ50



Oil mist filter
MFZ50



Micro oil mist filter
MMFZ50

Down sizing

Improved flow rate characteristics allow a smaller configuration (close side-by-side spacing possible).

Visible filter element

It is easy to check the state of the filter element.

Short type bowl

Compact size. The amount of oil used in component parts is very small.

Compatible in a wide range of environments

Specifications for ozone resistance, NCU specifications (copper free) compatible as standard.



Compact design

Improved flow rate characteristics allow a smaller configuration.

★ Comparison of our mist filter **MF300** and oil filter **MFZ40**

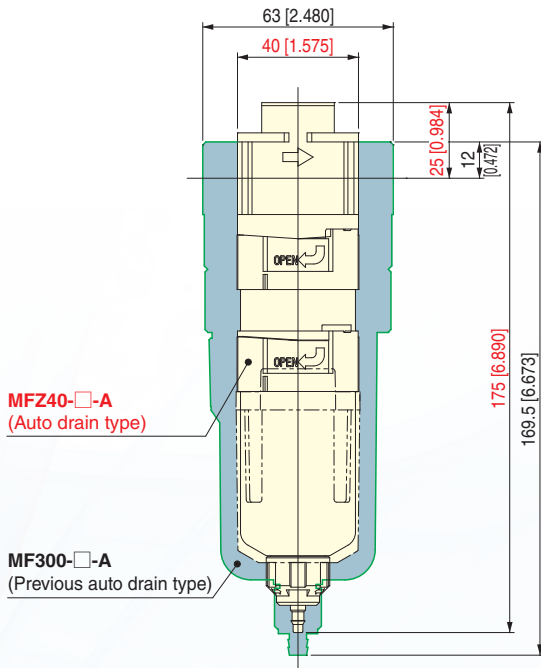

Improved visibility of the filter element

Changes in the flow path and the clear holder make it easy to monitor the element while in use because dirt adheres to the outside of the element.

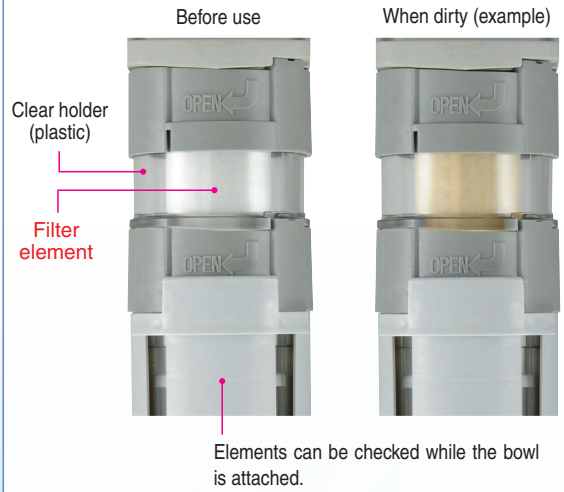

Drain cock specifications

Drain cock with fitting or auto drain types can be selected.



Auto drain type
NO (Normally open)
NC (Normally closed)

Drain cock with fitting

Bowl guard (option)

Bowl guard option is available.



Bracket

The brackets can be used with all sizes of all filter regulators. Also, brackets can be used with the iB-Cyclone and others in the FRZ series.















Short type bowl

Compact short type bowls are available.

Note: It cannot be used with air that contains moisture or fluids because there is no function to remove moisture or fluids.



FRZ series and iB-Cyclone system displays

Series name	Specifications	Model	Port size					Catalog No.
			M5	1/8	1/4	3/8	1/2	
			M5	01	02	03	04	
 <p>Filter regulator with no drain cock</p>	Standard	FRZ30	●	●	●			No. BK-E0006 No. BK-E0010 (NPT thread specifications) 
		FRZ40		●	●	●		
		FRZ50			●	●	●	
	For low pressure	FRZ31	●	●	●			
		FRZ41		●	●	●		
		FRZ51			●	●	●	
Built-in check mechanism	FRZ32	●	●	●				
 <p>Filter regulator with drain cock</p>	Standard	FRZB30	●	●	●		No. BK-E0008 No. BK-E0011 (NPT thread specifications) 	
		FRZB40		●	●	●		
		FRZB50			●	●		●
	For low pressure	FRZB31	●	●	●			
		FRZB41		●	●	●		
		FRZB51			●	●		●
Built-in check mechanism	FRZB32	●	●	●				
 <p>Air filter</p>	5 μm filtration	FNZ30		●	●		No. BK-E0012 	
		FNZ40		●	●	●		
		FNZ50			●	●		●
	40 μm filtration	FNZ31		●	●			
		FNZ41		●	●	●		
		FNZ51			●	●		●
 <p>Oil mist filter</p>	0.3 μm filtration	MFZ30		●	●			
		MFZ40		●	●	●		
		MFZ50			●	●	●	
 <p>Micro oil mist filter</p>	0.01 μm filtration	MMFZ30		●	●			
		MMFZ40		●	●	●		
		MMFZ50			●	●	●	
 <p>Regulator</p>	Standard	RZ30	●	●	●		No. BK-E0006 No. BK-E0010 (NPT thread specifications) 	
		RZ40		●	●	●		
		RZ50			●	●		●
	For low pressure	RZ31	●	●	●			
		RZ41		●	●	●		
		RZ51			●	●		●
Built-in check mechanism	RZ32	●	●	●				
 <p>Residual pressure exhaust valve</p>	—	50VZ		●	●	●	●	
 <p>iB-Cyclone (Drain separator)</p>	—	IBC30		●	●		No. BK-E0007 No. BK-E0009 (NPT thread specifications) No. BK-E0013 (G thread specifications) 	
		IBC40		●	●	●		
		IBC50			●	●		●
	—		—					

Systems can be upgraded with modules!

The optimum system can be constructed by using D modules and various modules for a tailored fit.

Note: Only the 40 and 50 series body sizes support modular configuration. The 30 series body size cannot be combined and configured with modules. It is for standalone use only.

1. Examples of various combinations

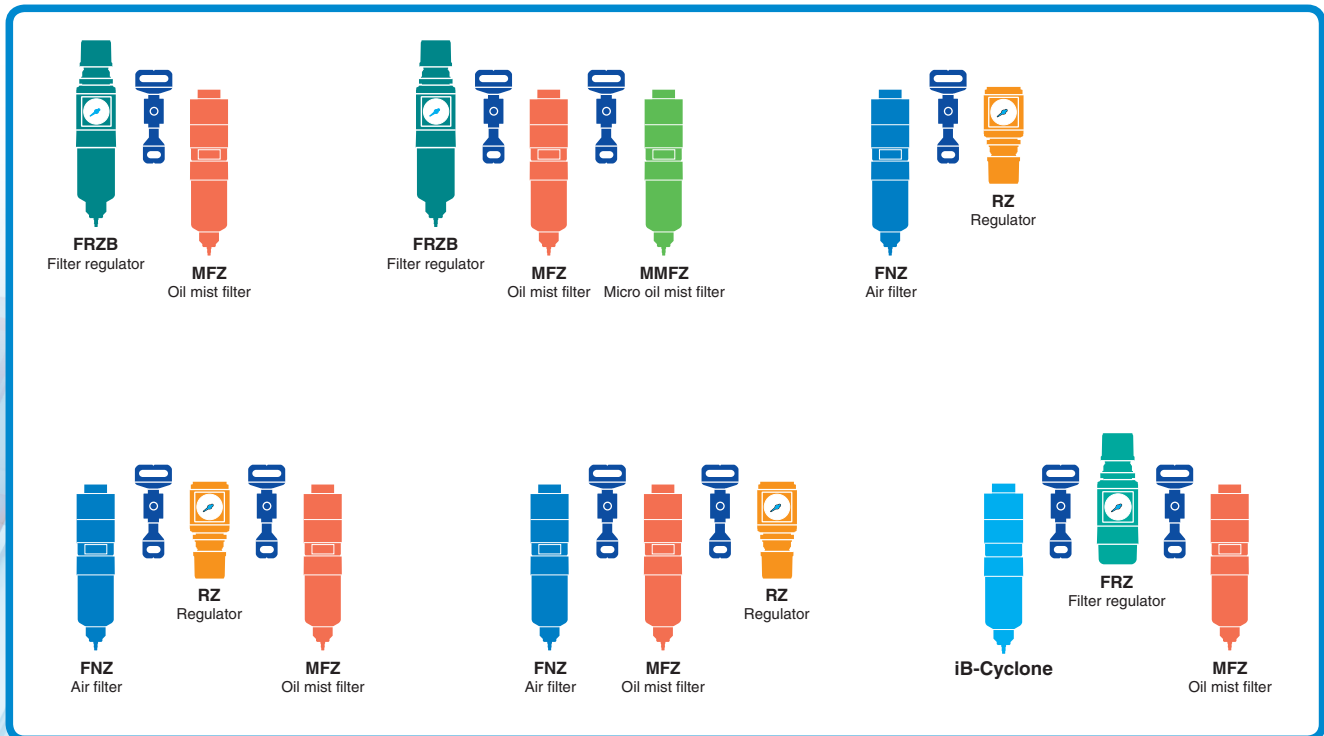

2. Examples of filter modules combinations

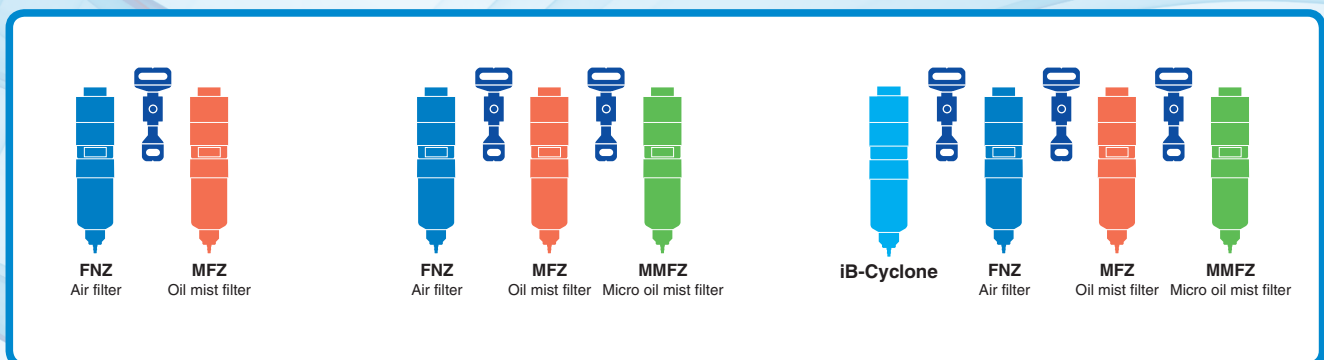









List of products that are compatible with modules

Body size	Model	40 series						50 series					
		FRZ(B)40	IBCY40	FNZ40	MFZ40	MMFZ40	RZ40	FRZ(B)50	IBCY50	FNZ50	MFZ50	MMFZ50	RZ50
40 series	FRZ(B)40	8Z-F (F module) 8Z-D (D module with bracket) 8Z-T □ (T module) 8Z-DT □ (DT module with bracket) 8Z-S □ (S adapter) 8Z-DS □ (DS adapter with bracket) 8Z-PS □ (pressure switch module) 8Z-DPS □ (pressure switch module with bracket)											
	IBCY40												
	FNZ40												
	MFZ40												
	MMFZ40												
	RZ40												
50 series	FRZ(B)50												
	IBCY50												
	FNZ50												
	MFZ50												
	MMFZ50												
	RZ50												
	50VZ												

Note: Only the 40 and 50 series body sizes support modular configuration. The 30 series body size cannot be combined and configured with modules. It is for standalone use only.

List of module and adapter models

For the 40 and 50 series body sizes

Module or adapter	F module	D module	T module	DT module	S adapter	DS adapter	Pressure switch module	Pressure switch module
	For connecting	For connecting (with bracket)	For branching	For branching (with bracket)	For pipe size conversion	For pipe size conversion (with bracket)	For module mounting only	For module mounting only (with bracket)
Body size								
40 series	8Z-F	8Z-D	8Z-T □	8Z-DT □	8Z-S □	8Z-DS □	8Z-PS □	8Z-DPS □
50 series								

Examples of combinations

iB-Cyclone

(Moisture separator)

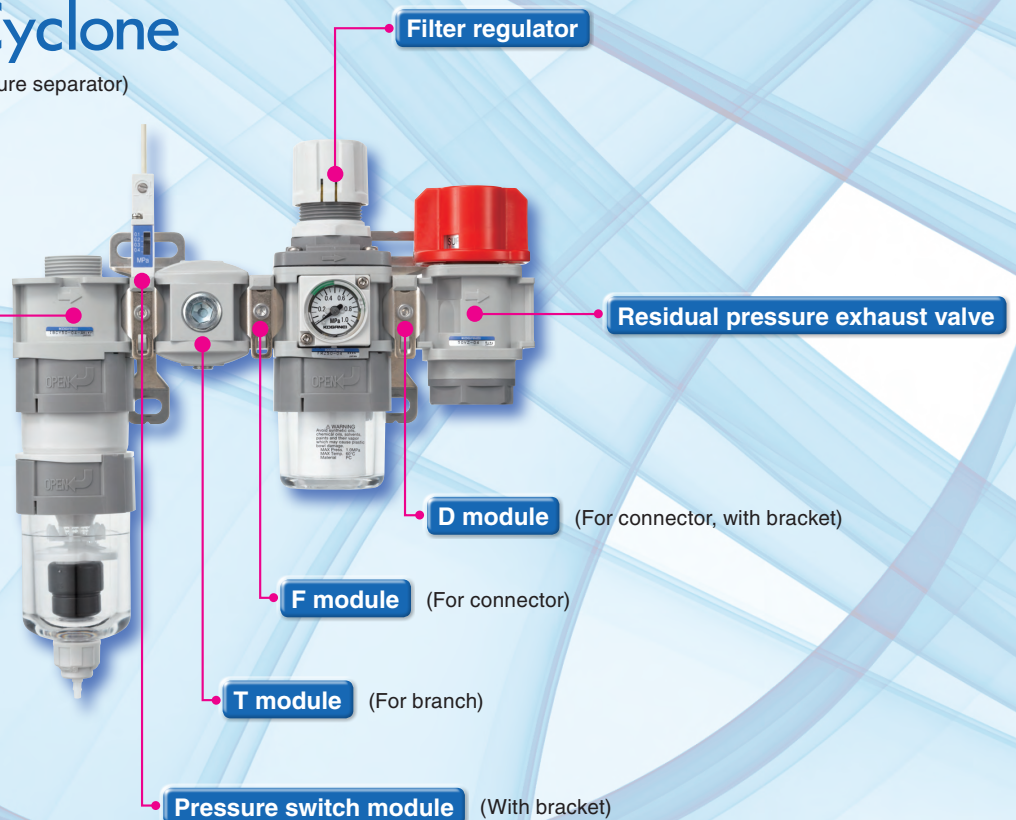

Guide to related products

Perfect on lines following the removal of moisture and fluids!

Specialized **30 series**
for standalone application

Can be used in combination
40 and 50 series



Regulator
RZ30



Filter regulator
FRZ30



Regulator
RZ40



Filter regulator
FRZ40



Regulator
RZ50



Filter regulator
FRZ50

Easy-to-use moisture and fluid removal functions in a compact design!



Filter regulator
FRZB30



Filter regulator
FRZB40



Filter regulator
FRZB50



In combination with the iB-Cyclone!



CMZ550







CMZ550-V

Before selecting and using the products, please read all the safety precautions carefully to ensure proper product use.

The safety precautions described below are to help you use the product safely and correctly, and to prevent injury or damage to you, other people, and assets.

Always adhere to the following safety regulations: ISO4414 (Pneumatic fluid power - General rules and safety requirements for systems and their components) and JIS B 8370 (Pneumatic system regulations).

The directions are ranked according to degree of potential danger or damage: DANGER, WARNING, CAUTION, and ATTENTION

 DANGER	Indicates situations that can be clearly predicted as dangerous. Death or serious injury may result if the situation is not avoided. It could also result in damage or destruction of assets.
 WARNING	Indicates situations that, while not immediately dangerous, could become dangerous. Death or serious injury may result if the situation is not avoided. It could also result in damage or destruction of assets.
 CAUTION	Indicates situations that, while not immediately dangerous, could become dangerous. Failure to avoid the situation creates the risk of minor or semi-serious injury. It could also result in damage or destruction of assets.
 ATTENTION	While there is no chance of injury, these points should be observed for appropriate use of the product.

■ This product was designed and manufactured for use in general industrial machinery.

- When selecting and handling equipment, the system designer or another person with sufficient knowledge and experience should always read the safety precautions, catalog, instruction manual and other literature before commencing operation. Improper handling is dangerous.
- After reading the Instruction Manual, catalog, and other documentation, always store them in a location that allows easy availability for reference to users of this product.
- Whenever transferring or lending the product to another person, always attach the instruction manual, and other information, to the product where they are easily visible in order to ensure that the new user can use the product safely and properly.
- The danger, warning, and caution items listed under these safety precautions do not cover all possible contingencies. Read the catalog and instruction manual carefully, and always keep safety first.

 **DANGER**

- Do not use the product for the purposes listed below:
 1. Medical equipment related to maintenance or management of human lives or bodies
 2. Machines or equipment designed for the purpose of moving or transporting people
 3. Critical safety components in mechanical devices
 This product has not been planned or designed for purposes that require high levels of safety. Using the product in any of the ways described above creates the risk of loss of human life.
- Do not use the product in locations with or near dangerous substances such as flammable or ignitable substances. This product is not explosion-proof. Doing so creates the risk of ignition and fire.
- When mounting the product and workpiece, always make sure they are firmly supported and secured in place. Falling, dropping, or abnormal operation of the product creates the risk of personal injury.
- Never attempt to modify the product in any way. Abnormal operation can lead to injury.
- Never attempt inappropriate disassembly, assembly or repair of the product relating to basic construction, or to its performance or to functions. Doing so creates the risk of injury.
- Do not splash water on the product. Spraying it with water, washing it, or using it under water could result in malfunction leading to injury, etc.
- While the product is in operation, avoid touching it with your hands or otherwise approaching too close except for specified operations. Also, do not attempt to make any adjustments to internal or attached mechanisms, or to perform any type of adjustment (disconnecting tubes or sealed plugs, adjustment of the product's mounting position, etc.) while the product is in operation. Falling, dropping, or abnormal operation of the product creates the risk of personal injury.

 **WARNING**

- Because Koganei products may be used under a wide variety of conditions, decisions concerning conformance with a particular system should be made upon the careful evaluation by the person in charge of system design. Assurances concerning expected system performance and safety are the responsibility of the designer who decides system conformity. Be sure to use the latest catalogs and technical materials to study and evaluate specification details, to consider the possibility of machine breakdown, and to configure a system that ensures fail-safe safety and reliability.
- Do not use the product in excess of its specification range. Doing so creates the risk of product breakdown, loss of function, or damage. It could also drastically reduce operating life.
- Before supplying air or electricity to the device and before starting operation, always conduct a safety check of the area where the machine

is operating. Unintentional supply of air or electricity creates the risk of injury due to contact with moving parts.

- Do not allow the product to be thrown into fire. Doing so creates the risk of explosion and the release of toxic gases.
- Do not sit on the product, place your foot on it, or place other objects on it. Doing so creates the risk of injury due to tripping or the product tipping over or falling, resulting in product damage and abnormal, erratic, or runaway operation.
- Before conducting maintenance, inspection, repair, replacement, or any other similar procedure, always completely cut off all air and connections and check that residual pressure inside the product or in piping connected to the product is atmospheric pressure. In particular, be aware that residual air will still be in the compressor or air tank. The actuator may move abruptly if residual air pressure remains inside the piping, causing injury.
- Use safety circuits or design a system that prevents damage to machinery and personal injury when the machine is shut down due to an emergency stop or electrical power failure.
- Always check the catalog and other reference materials for correct product piping. Improper piping creates the risk of damage to and abnormal operation of the actuator.
- After completing piping work, check to make sure that all circuits are correct before supplying air.
- Do not use any type of medium that is not specifically stipulated in the specifications. Using a non-specified medium could lead to short term loss of function, sudden degradation of performance, and a reduced operating life.
- When the product has been idle for over 48 hours or has been in storage, it is possible that the contacting parts may have become stuck leading to operating delays or sudden movements. Before initial operations, always run a test to check that operating performance is normal.
- Do not use the product in locations that are subject to direct sunlight (ultraviolet rays); locations with high humidity and temperature, dust, salt, or iron powder. Do not use fluids in the product or use the product in an environment that includes corrosive fluids such as organic solvents, phosphate ester type hydraulic oil, sulfur dioxide, chlorine gas, acids, etc. It could lead to early shutdown of some functions, a sudden degradation of performance, and a reduced operating life. For information about materials, see Major Parts and Materials.
- When the device has not been used for long periods (over 30 days), it is possible that the contacting parts may have become stuck leading to slow operation or sudden movements. Check for proper operation a minimum of once every 30 days.
- Do not use the product near the ocean in direct sunlight, near mercury vapor, or near equipment that generates ozone. Deterioration of rubber parts caused by ozone may reduce performance and functions or stop functions.
- Do not use in locations where there is a heat source nearby or that are subject to radiated heat.

Safety Precautions

CAUTION

- When installing the product, be sure to allow adequate work space around it. Failure to do so will make it more difficult to conduct daily inspections or maintenance, which could eventually lead to system shutdown or damage to the product.
- When transporting or mounting a heavy product, firmly support the product using a lift or support, or use multiple people to ensure personal safety.
- Do not scratch, dent, or deform the product by climbing on it, using it as a step, or placing objects on top of it. Doing so creates the risk of damage to or breakage of the product, resulting in operational shutdown or degraded performance.
- Always post an "operations in progress" sign for installations, adjustments, or other operations, to avoid unintentional supplying of air or electrical power, etc. Unintended power supply can cause electric shock and sudden operation, creating the risk of personal injury.
- When handling the product, take care to avoid dropping it, allowing it to come into contact with other objects, or otherwise subjecting it to excessive impact. Even if the exterior of the product appears undamaged, damage to internal components can cause abnormal operation.
- Use the specified lubrication when lubricating the sliding parts. Not doing this leads to changes in the physical properties and deterioration of the materials used, resulting in reduced functionality.
- Using extremely dry air with a dew point lower than $-20\text{ }^{\circ}\text{C}$, may affect the quality of the lubricating oil used. This creates the risk of degraded performance, loss of function, or other problems.

ATTENTION

- Whenever considering use of this product in situations or environments not specifically noted in the catalog or in manuals, or in applications where safety is an important requirement such as in aircraft facilities, combustion equipment, leisure equipment, safety equipment, and other places where human life or assets may be greatly affected, take adequate safety precautions such as allowing plenty of margin for ratings and performance, or fail-safe measures. Be sure to contact Koganei before use in such applications.
- Moving parts of machinery should be isolated with protective covers so as not to come into direct contact with human bodies.
- Do not configure controls that would allow workpieces to fall if power fails.
Configure control of the actuator to prevent the rod, workpieces, and other items from falling due to power failure or by emergency stoppage of mechanical devices.
- When handling the product, wear protective gloves, safety glasses, safety shoes, and other protective clothing whenever necessary.
- When the product can no longer be used or is no longer necessary, dispose of it appropriately as industrial waste.
- Pneumatic equipment can exhibit degraded performance and function over its operating life. Always conduct daily inspections of the pneumatic equipment, and confirm that all requisite system functions are satisfied, to prevent accidents from happening.
- For inquiries about the product, consult your nearest Koganei sales office or Koganei Overseas Department. The addresses and telephone numbers are shown on the back cover of this catalog.

Other

- Always observe the following items.
 1. When using this product in pneumatic systems, always use genuine Koganei parts or compatible parts (recommended parts).
Use only authentic Koganei parts or compatible parts (recommended parts) to do maintenance or repairs.
Always observe the prescribed methods and procedures.
 2. Never inappropriately disassemble or modify the product in relation to its basic construction, performance, or functions.

Koganei cannot be held responsible for any problems that occur as a result of these safety precautions not being properly observed.

Warranty and General Disclaimer

1. Warranty Period
The warranty period for Koganei products is 12 months from the date of delivery.
2. Scope of Warranty and General Disclaimer
 - (1) The Koganei product warranty covers individual products. When a product purchased from Koganei or from an authorized Koganei distributor or agent malfunctions during the warranty period in a way that is attributable to Koganei's responsibility, Koganei will repair or replace the product free of charge. Even if a product is still within the warranty period, its durability is determined by its operation cycles and other factors. Contact your nearest Koganei sales office or the Koganei overseas department for details.
 - (2) Koganei is not responsible for any losses or for any damages to other machinery caused by breakdown, loss of function, or loss of performance of Koganei products.
 - (3) Koganei is not responsible for any losses due to use or storage of the product in a way that is outside of the product specifications prescribed in Koganei catalogs and instruction manuals, and/or due to actions that violate the mounting, installation, adjustment, maintenance or other safety precautions.
 - (4) Koganei is not responsible for any losses caused by breakdown of the product due to factors outside the responsibility of Koganei, including but not limited to fire, natural disaster, the actions of third parties, and intentional actions or errors by the purchaser.

Handling Instructions and Precautions

Design and selection

● Selection

See the Handling Instructions and Precautions, Specifications, Various Characteristics, Dimensions, and other technical materials for each product to make the correct decision.

Mounting (installation) and piping

● Mounting (installation) direction, support, and securing

1. The products cannot be mounted (installed) if a bending moment or twisting moment is applied to the product or piping.

Note Applying bending moment or twisting moment may damage the product.

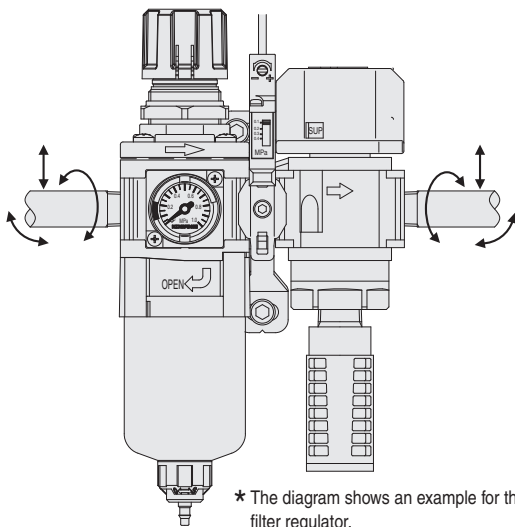

2. Do not attach piping so that just one side is fixed as shown in the following diagram. Support external piping separately.

Note The moment caused by the OUT (secondary) side pipes may damage the product's piping connections.

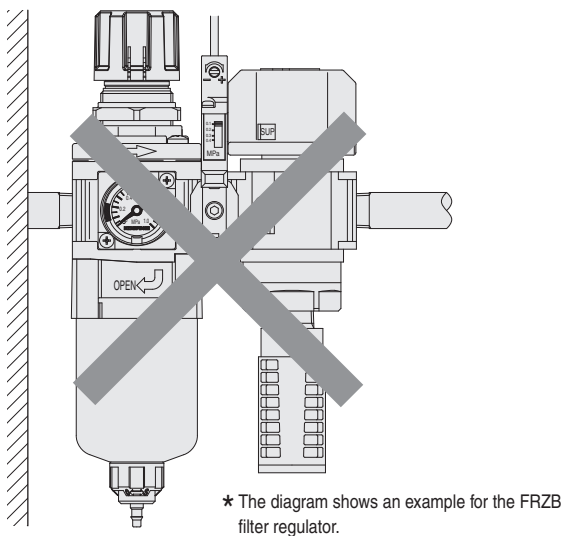

3. Use the brackets to install the products.

4. When mounting (installing) products, always make sure they are secured and sufficiently supported.

Note If a product is not securely fixed in place, it may fall over, be dropped, or operate abnormally and cause an injury.

● Maintenance space requirements

Assure there is sufficient space for maintenance inspections and maintenance work.

See the dimension diagrams for each of the products regarding the maintenance space.

Note If there is not enough allowance for maintenance space, it is impossible to remove the bowl assembly and replace the filter. Also, it is impossible to do maintenance inspections so the equipment may stop or the product may be damaged.

● Attaching steel pipes and fittings

If steel pipes and fittings are attached to the threaded sections of the aluminum die-cast parts of the product, tighten them to the torque recommended in our standards.

Note Tightening with excessive torque may damage the product or injure workers or operators.

Recommended tightening torque

Connecting thread	1/8	1/4	3/8	1/2
Torque	7 to 9 [5.2 to 6.6]	12 to 14 [8.9 to 10.3]	22 to 24 [16.2 to 17.7]	28 to 30 [20.7 to 22.1]

N•m [ft•lbf]

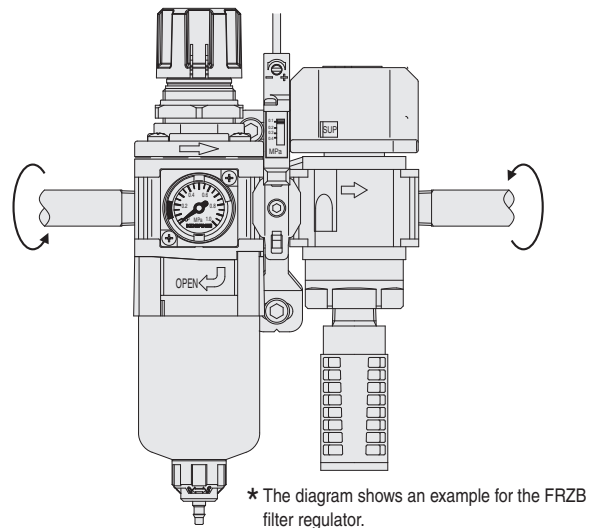

● Preventing contamination by foreign matter

1. Remove all foreign matter, such as metal chips, cutting oil, or dirt, from inside pipes with a compressed air blower (flushing) and thorough washing before fitting the pipes.

2. Do not allow foreign matter, such as metal chips, or sealing tape from the piping threads, to get into the pipes when installing the pipes and fittings.

Note Foreign matter entering the piping may damage the product or reduce its performance and service life.

3. Wrap the sealing tape in the direction as shown in the diagram below leaving 1.5 to 2 threads uncovered. When using liquid sealant, apply a suitable amount and in the same way leave 1.5 to 2 threads uncovered.

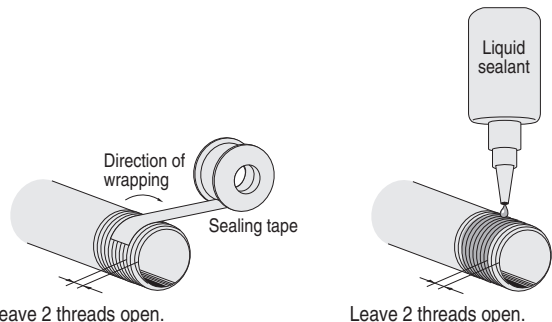

Note If the sealing tape or sealant gets on the lip of pipes or fittings, bits of it may get into the pipes and cause air leaks.

4. If you are using liquid sealant, do not get it on the polycarbonate parts (the bowl of the filter regulator).



If liquid sealant gets on the polycarbonate parts, it may damage them.

Medium and operating environment

● Usable medium

1. Use cleaned air for the medium. Contact the nearest Koganei sales office or overseas department if you are considering using something other than cleaned air.
 - For MFZ
Install the FNZ air filter on the primary side to avoid premature clogging.
 - For MMFZ
Install the MFZ oil mist filter on the primary side to avoid premature clogging.
2. For drain cock specifications (-A, -C, -N), avoid using air that contains too much water or fluids.



Using air that contains too much water or fluids will cause the product's functions to stop after a short period and will reduce the product performance and service life.

3. For drain cock specification (-S), it cannot be used with air that contains water or fluids because there is no function to remove water or fluids.



Using air that contains water or fluids will cause the product's functions to stop after a short period and will reduce the product performance and service life.

4. If air that contains water or fluids is used, or if it is possible that they may be mixed in with the air being used, we recommend using the iB-Cyclone to reliably remove water and fluids.

5. Do not use the product if the media being used is prone to extreme pulsating or surging.



Medium prone to extreme pulsating or surges will cause the product's functions to stop after a short period and will reduce the product performance and service life.

● Operating environment

1. Do not use the product in locations that are subject to direct sunlight (ultraviolet rays); locations with high humidity and temperature, dust, salt, or iron powder.
2. Cover the unit when using it in locations where it might be subject to excessive dust, dripping water, dripping oil, etc.
3. Do not use the product in environments subject to external vibration or impact.



External vibrations or shocks may result in damage to component parts.

4. Avoid piping that is rigid, such as steel piping, if vibrations are transmitted. Use flexible tubes so that the product is not subject to the vibrations.

● Medium and operating environment

1. The temperature of the medium and the ambient environment must be within the range in the specifications.



Using the product in an environment that is outside the specified temperature or with media that is outside the specified temperature will cause the product's functions to stop after a short period and will reduce the product performance and service life.

2. Use a device, such as a freeze-type air dryer or after cooler, to lower the dew-point temperature of the medium to below the ambient temperature so condensation or frost does not occur in the secondary pipes.



If condensation or frost forms in the product, it may get into the secondary side.

3. Do not use medium in the product or use the product in an environment that includes corrosive components such as organic solvents, phosphate ester type hydraulic oil, sulfur dioxide, chlorine gas, freon gas, ozone, acids, alkaline, etc.



Using the product in an environment or with medium that is specified in the above item 3 will cause the product's functions to stop after a short period and will reduce the product performance and service life.

4. The material of the bowl of the filter is polycarbonate. This product cannot be used in environments with the gases and fluids in item 3, nor thread-locking adhesive, leak detection fluid, hot water or where it may be exposed to them. This product also cannot be used in direct ultra-violet light. See the reference materials on page 16 for details.

Operation and maintenance inspections

● Method of use

Read the Handling Instructions and Precautions for each product for instructions on correct usage.

● Maintenance (maintenance inspection)

1. Performance and functions may decrease as the pneumatic equipment ages. Always conduct daily inspections of the pneumatic equipment, and confirm that all requisite system functions are satisfied, to prevent accidents from happening.
2. Read the Handling Instructions and Precautions for instructions on maintenance and replacing maintenance parts.
3. The product must be disassembled and reassembled to use the seal kit.



The product is no longer under warranty if it is disassembled and reassembled.

Handling Instructions and Precautions

Design and selection

● Direct installation on compressor

Do not install the product directly on a compressor. Use sufficient countermeasures for temperature control, and removing oils and solids before use.



Not using countermeasures may cause the product's functions to stop after a short period and may reduce the product performance and service life.

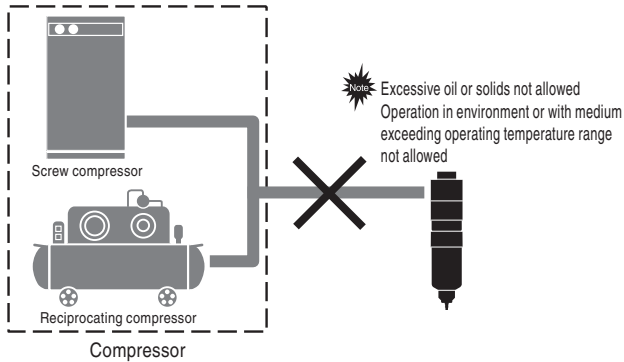

● Water and fluids removal functions

The FRZ series air filters, micro oil mist filters, and oil mist filters cannot reliably remove water and fluids.



Use an iB-Cyclone to completely remove moisture and fluid.

● Humidity removal

Air filters, micro oil mist filters, and oil mist filters cannot dehumidify.



Install a membrane air dryer or something on the secondary side if dehumidifying is needed.

Mounting (installation) and piping

● Mounting (installation) direction

Mount (install) the air filter, micro oil mist filter, or oil mist filter vertically so the drain outlet is down.

● Direction of flow

1. Connect the air filter, micro oil mist filter, or oil mist filter so that the medium flows in the IN port (primary) side and flows out the OUT port (secondary) side.
2. Use the flow marks on the products to identify the primary port and secondary port of the air filter, micro oil mist filter, or oil mist filter.



Reversing the IN port (primary) side and the OUT port (secondary) side connections damages the product and causes it to stop functioning.

● Flow mark

The following diagram shows the relationship of the direction of flow of the medium and the flow mark on the air filter, micro oil mist filter, and oil mist filter.

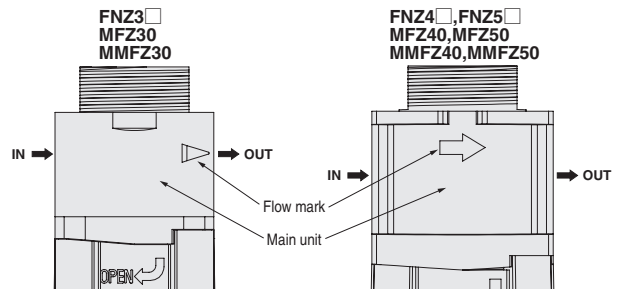

● Piping work

Connect steel pipes and fittings to the air filter, micro oil mist filter, or oil mist filter IN ports and OUT ports so that the weight and torque of the pipes do not affect the product. When tightening the piping, grip the main unit and tighten it to the torque recommended on page 9.



Applying unnecessary force or impact to the holder or bowl assembly may damage component parts.

● Installing brackets

To install brackets, do it in the following order.

1. Detach the bracket.
2. Screw on the mounting ring.



Tighten the mounting ring to less than 5.0 N·m [3.69 ft·lbf].

● Mounting ring

1. Tighten the mounting ring to less than 5.0 N·m [3.69 ft·lbf].
2. If you use a tool to tighten the mounting ring, be sure to firmly grip the opposite edges of the mounting ring.



If the mounting ring is not firmly gripped or too much torque is applied to it, component parts may be damaged.

Operation and maintenance inspections

● Clear plastic parts (holder and bowl assembly)

1. Do periodic inspections to look for cracks, scratches, or other deterioration in the clear plastic parts. If you detect any cracks, scratches, or other deterioration, immediately stop use.
2. If you find any cracks, scratches, or other deterioration in the bowl, replace the bowl assembly with a new one, because it may cause a breakdown.



Cracks, scratches, or other deterioration may cause the bowl to break.

3. Replace the bowl assembly with a new one if it becomes dirty or the transparency is reduced. To wash the bowl holder, use diluted household cleaner to wash it and then rinse it off with water. See the reference materials on page 16 for details about the chemical resistance of the bowl holder material.
4. When replacing the seal kit, element, and bowl assembly, be careful not to lose component parts.
5. Refer to page 13 when replacing the seal kit, element, and bowl assembly.

● Drain cock operation

1. Turn the drain cock with your hand.
2. Use the following procedure to operate the drain cock.
 1. Turn the drain cock in the direction of [O].
 2. After the water and fluids have drained out, turn the drain cock in the direction of [S] until it clicks and locks.
3. Do not turn the drain cock more than 100° from the closed position, when you open it.



Turning the drain cock more than 100° may damage it.

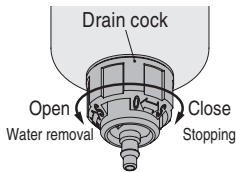

● Draining oil and fluid

1. If the regulator you are using has no auto drain (-N), be sure to drain the water and fluids before their volume reaches the level shown in the left side diagram below.



If the volume of water and fluids is greater than that shown in the left side diagram below, the water and fluids removal function is greatly reduced.

2. If the regulator you are using has an auto drain (-A or -C), the water and fluids that collects on the primary side is flushed all at once, do not let it exceed the maximum level as shown in the right side diagram below.



The auto drain may malfunction if the volume of water and fluids exceeds the maximum level as shown in the left side diagram below.

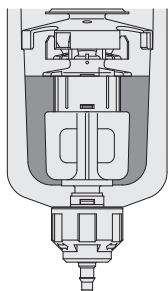

For -N

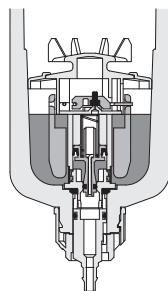

For -A or -C

3. See the reference material on page 14 "Explanation of operation of auto drain system" regarding the auto drain operation principles.
4. A tube with an inner diameter of $\phi 4$ [0.157 in] can be attached to the barbed fitting of the drain cock. Make sure the drain cock is closed (locked) before attaching the tube.
5. Cut the end of the tube to be connected to the barbed fitting of the drain cock straight across, and the barbed fitting must be inserted completely as shown in the diagram. Also, after installing the tube, lightly pull on it to check that it does not come off.
6. Do not allow the tube on the barbed fitting of the drain cock to become severely bent or twisted close to the fitting.



Lateral force may damage the barbed fitting.

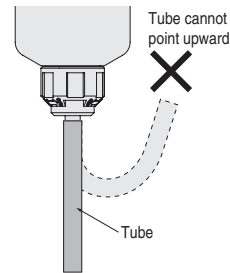

● Attaching and removing the bowl assembly

1. Be sure to release any pressure in the system before attaching (or removing) the bowl assembly.
2. Use the procedure shown in the diagram below to attach (or remove) the bowl assembly.
3. Squeeze the guard button to attach (or remove) the bowl assembly.



If there is a bowl guard, it may fall off when you squeeze it.

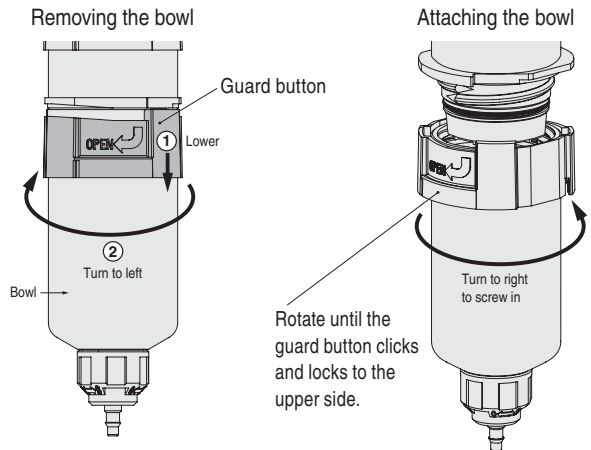

4. When attaching or removing the bowl assembly, move it vertically so you do not touch the internal component parts.

Handling Instructions and Precautions

● Attaching and removing the bowl guard

1. Be sure to release any pressure in the system before attaching or removing the bowl guard.
2. Use the procedure shown in the diagram below to attach (or remove) the bowl guard.

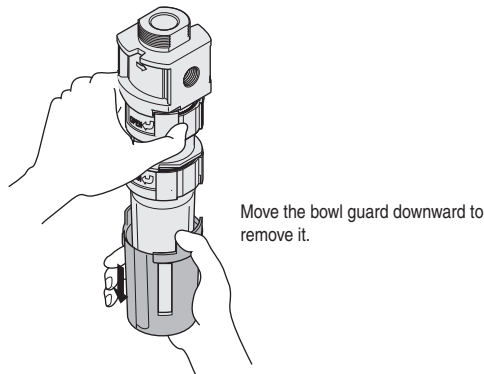
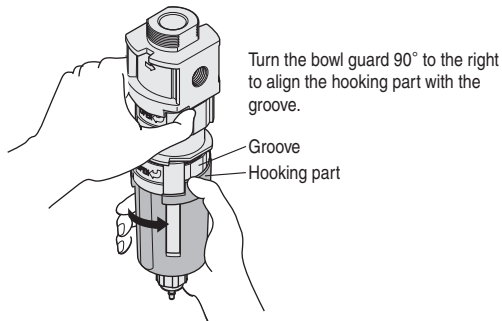
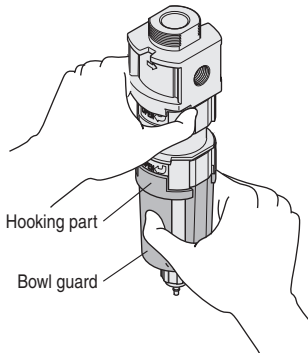

3. Use the reverse of the procedure shown in the diagram above to attach the bowl guard.

● Replacing the seal kit, element, and bowl assembly

1. To replace the seal kit, element, and bowl assembly, remove the air filter, micro oil mist filter, or oil mist filter and do the work on a work table.
2. Periodically replace the element of the air filter, micro oil mist filter, or oil mist filter.

Note The service life of the element varies depending on the quality of air supplied to the IN port (primary) side. If the air supplied to the IN port (primary) side is highly contaminated with foreign matter, install a prefilter on the IN port (primary) side or change the air filter frequently. As a guideline, the replacement time for the element is one year after starting to use it.

Note Always assemble the component parts correctly.

● Assembly and disassembly diagrams

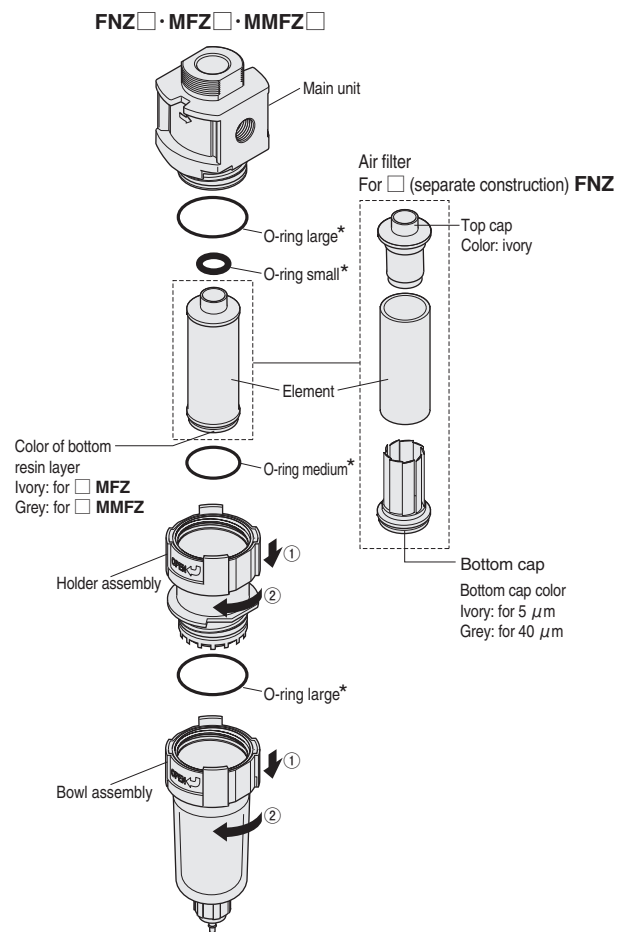

Note The product is no longer under warranty if it is disassembled and reassembled.

● Explanation of operation of auto drain system

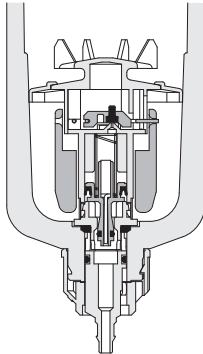
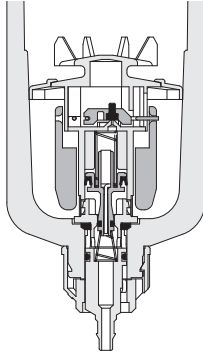
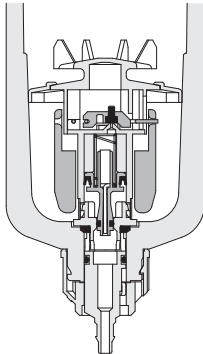
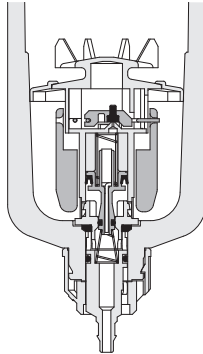
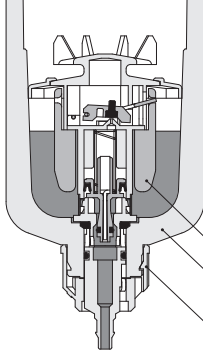
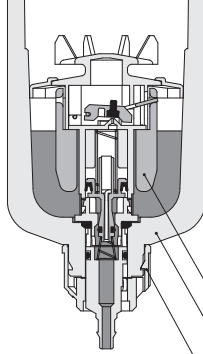
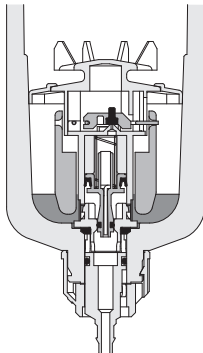
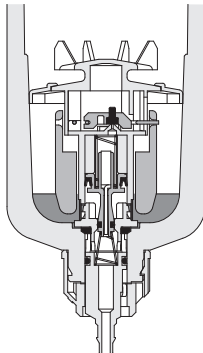
State	Type	NO type	NC type
Not pressurized	NO type	 <p>Open</p> <p>When unpressurized, the liquid outlet opens and the liquid drains naturally.</p>	 <p>Close</p> <p>When unpressurized, the liquid outlet closes and the liquid cannot drain.</p> <p>Note: Liquid does not drain when unpressurized, if there is a lot of liquid even in an unpressurized (low pressure) condition, it may be necessary to drain the liquid by hand.</p>
		 <p>Close</p> <p>Air and liquid will be discharged from the liquid outlet until the pressure exceeds the minimum operating pressure (0.15 MPa [22 psi]). The air and liquid will stop after stored pressure exceeds the minimum operating pressure.</p> <p>Note: A compressor with a small output may not reach full pressure, and there may be air output until the minimum operating pressure is exceeded.</p>	 <p>Close</p> <p>In the same way, when unpressurized, the liquid outlet closes and the liquid cannot drain.</p>
Draining liquid	NO type	 <p>Open</p> <p>When the level of liquid in the bowl reaches a specified level, the float lifts and the liquid automatically drains.</p> <p>Note: Moisture can be drained manually by turning the drain knob to the left. See page 12 for details.</p> <p>Float Bowl Drain knob</p>	 <p>Open</p> <p>When the level of liquid in the bowl reaches a specified level, the float lifts and the liquid automatically drains.</p> <p>Note 1: Supply pressure is needed to operate the auto drain. A minimum of 0.15 MPa [22 psi] is needed for the supply pressure. 2: Liquid can be drained manually by turning the drain knob. See page 12 for details.</p> <p>Float Bowl Drain knob</p>
		 <p>Close</p> <p>When the liquid drains, the float lowers and the liquid outlet closes, and liquid stops draining.</p>	 <p>Close</p> <p>When the liquid drains, the float lowers and the liquid outlet closes, and liquid stops draining.</p>

Handling Instructions and Precautions

● Principles of fluid and dirt removal from air filters

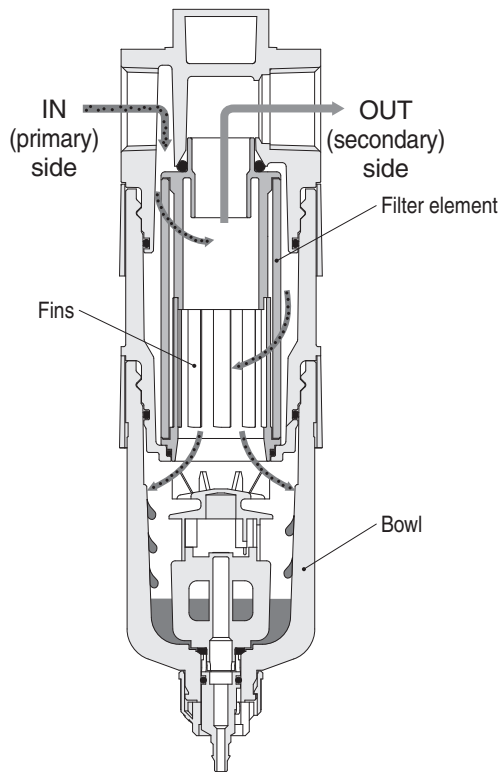

1. The element separates dirt from the air supplied from the IN port (primary) side.
2. Fluid aggregates due to the centrifugal separation from the swirling current created by the fins and collects in the bowl.
3. The air, from which the fluid and dirt have been separated, passes through the top part of the filter element to the OUT port (secondary).

● Principles of oil and dirt removal from micro oil mist filters and oil mist filters

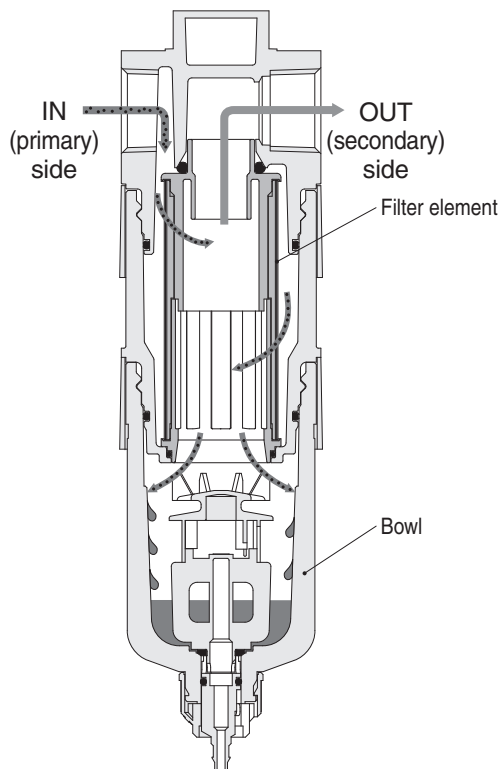

1. The element separates oil and dirt from the air supplied from the IN port (primary) side.
2. Oil aggregates due to the centrifugal separation from the swirling current created by the fins and collects in the bowl.
3. The air, from which the oil has been separated, passes through the top part of the filter element to the OUT port (secondary).

Reference material

● About the chemical resistance of polycarbonate

The chemicals in the following table degrade polycarbonate. Because of this, they may damage the bowl of the filter regulator or the front cover of the pressure gauge and cause an accident. The products cannot be used in locations where the chemicals in the following table are present in the compressed air, ambient air, or on surfaces. This does not mean that polycarbonate is chemically resistant to all chemicals not listed below.

Type	Classification	Chemical name	Application example
Inorganic compound	Acid	Hydrochloric acid, sulfuric acid, nitric acid, fluorine, phosphoric acid, chromic acid	Acid cleaning for metals, acid degreasing, and coating processing
	Alkali	Caustic soda, caustic potash, hydrated lime, ammonia water, sodium carbonate	Alkaline degreasing of metals
	Inorganic salt	Sodium sulfide, potassium nitrate, potassium dichromate, sodium nitrate	Dyes, rust inhibitor
Organic compounds	Aromatic hydrocarbons	Benzene, toluene, xylene, ethyl benzene, styrene	Paint thinner (Benzene, toluene, xylene)
	Chlorinated aliphatic hydrocarbons	Methyl chloride, ethylene chloride, methylene chloride, acetylene dichloride, chloroform, trichlene, tetrachloroethylene, carbon tetrachloride	Organic solvents for metal cleaning (trichlene, tetrachloroethylene, carbon tetrachloride)
	Chlorinated aromatic hydrocarbons	Chlorobenzene, dichlorobenzene, hexachloride (BHC)	Agricultural chemicals
	Petroleum components	Solvent, naphtha, gasoline	Fuel
	Alcohol	Methyl alcohol, ethyl alcohol, cyclohexanol, benzyl alcohol	Anti-freezing agents
	Phenol	Carbolic acid, cresol, naphthol	Antiseptic solutions
	Ether	Methyl ether, methyl ethyl ether, ethyl ether	Brake fluid additive, detergent
	Ketones	Acetone, methyl ethyl ketone, cyclohexane, acetophenone	Cleaning solutions
	Carboxylic acid	Formic acid, acetic acid, butyl acid, acrylic acid, oxalic acid, phthalic acid	Dyes, aluminum processing solution (oxalic acid), paint medium (phthalic acid)
	Phthalic acid ester	Dimethyl phthalate (DMP), diethyl phthalate (DEP), dibutyl phthalate (DBP), dioctyl phthalate (DOP)	Lubricants, synthetic hydraulic fluids, corrosion resistant additives, synthetic resin plasticizer
	Oxyacid	Glycolic acid, lactic acid, malic acid, citric acid, tartaric acid	Food preservatives, acidulant
	Nitro compounds	Nitromethane, nitroethane, nitroethylene, nitrobenzene	Paint solvent, explosives
	Amine	Methylamine, dioctylamine, ethylamine, aniline, acetanilide	Brake fluid additive
Nitrile	Acetonitrile, acrylonitrile, benzonitrile	Nitrile rubber materials	

Inner construction

- MFZ30
- MFZ40
- MFZ50

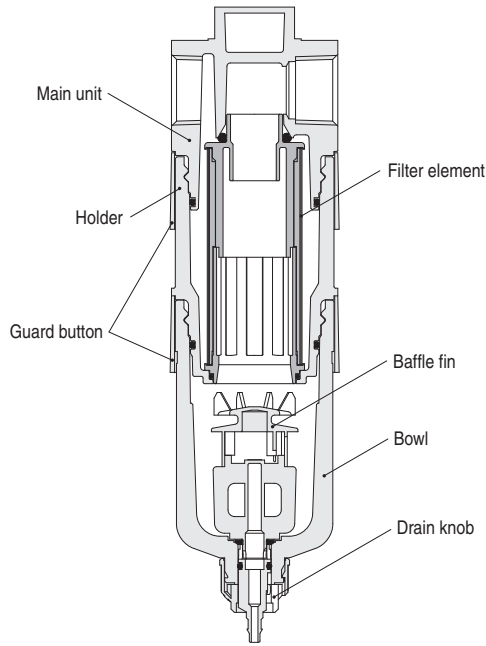

Flow rate characteristics

MFZ30-01

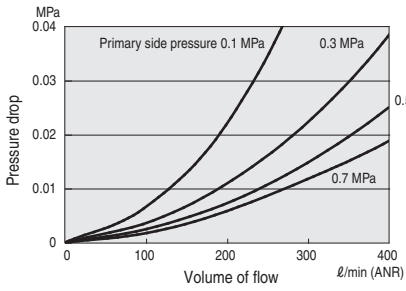

MFZ40-01

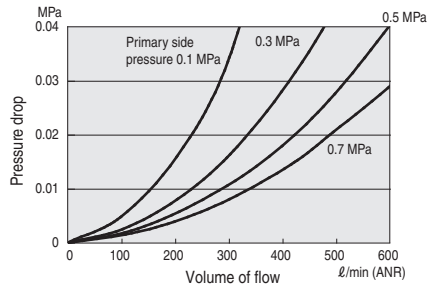

MFZ50-02

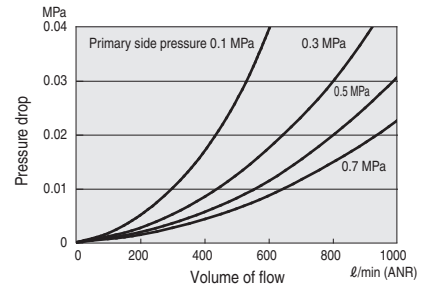

MFZ30-02

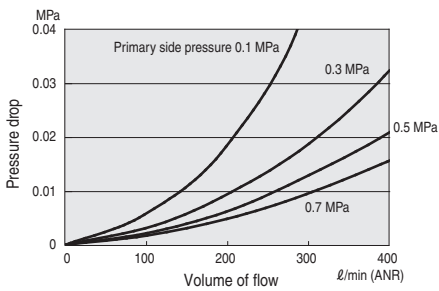

MFZ40-02

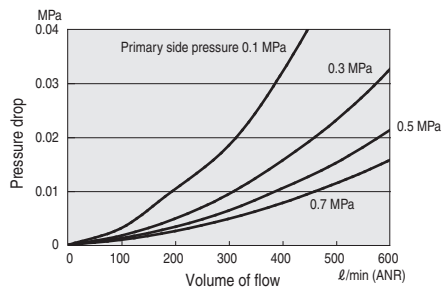

MFZ50-03

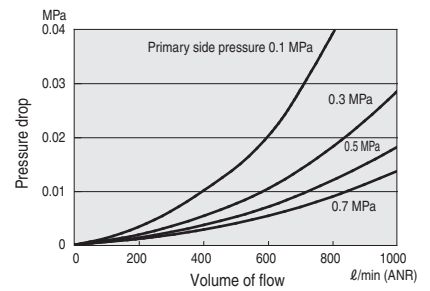

MFZ40-03

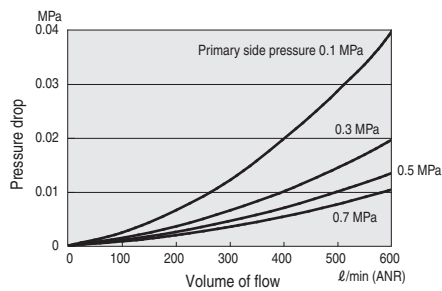

MFZ50-04

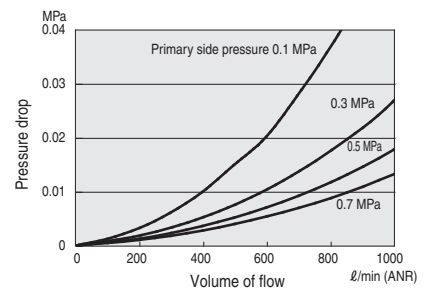

1 MPa = 145 psi
 1 ℓ /min = 0.0353 ft³/min

Bracket

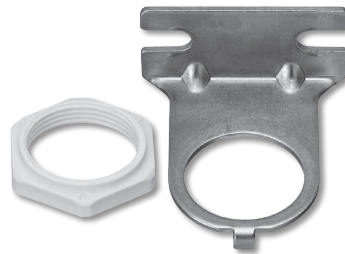

Bracket model and applicable equipment

■ For air filter, mist filter, and micromist filter

Equipment model	Bracket model	Remarks
Air filter	8Z-CBK	Main unit support and options
Mist filter		
Micromist filter		

[Materials used in major parts] Steel plate (electroless nickel plated)

Bracket dimensions mm [in]

■ For air filter, mist filter, and micromist filter

● 8Z-CBK

Bracket

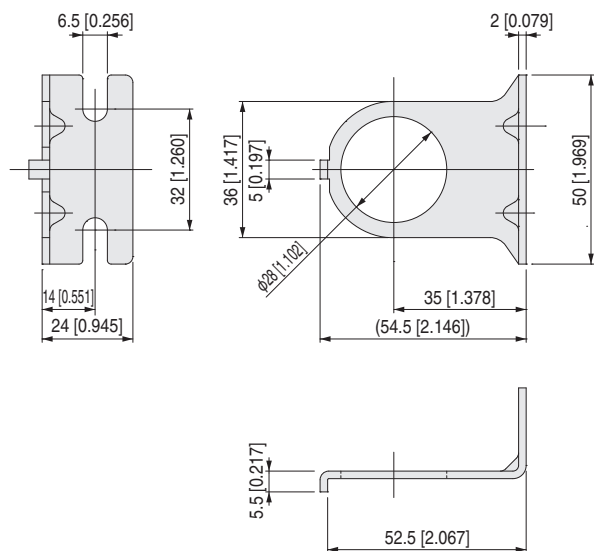

Mounting ring

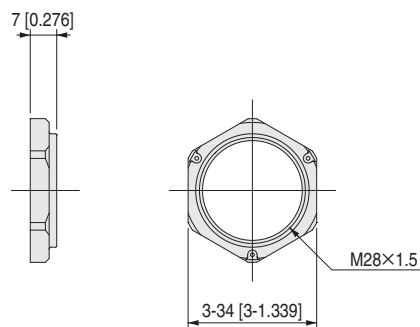

Other maintenance parts and order codes

● Order codes for brackets only

8Z-CBK

* With mounting ring
Common to all body sizes



8Z-BK

* Common to all body sizes



● Mounting ring

R-FRZ

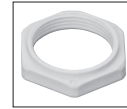

● Maintenance parts

● Bowl assembly

BA-FRZB-□-□-□

Body size

30 — for FNZ3□, MFZ30, and MMFZ30
40 — for FNZ4□, MFZ40, and MMFZ40
50 — for FNZ5□, MFZ50, and MMFZ50

Drain cock specifications

A — NO type auto drain type drain cock
C — NC type auto drain type drain cock
N — Drain cock with fitting

Bowl guard specifications

Blank — No bowl guard
PG — With bowl guard



Auto drain type
NO type
NC type



Drain cock with
fitting



With bowl guard

● Bowl assembly (-S no drain cock (short type))

BA-FRZ□

Body size

30 — for FNZ3□-S, MFZ30-S, and MMFZ30-S
40 — for FNZ4□-S, MFZ40-S, and MMFZ40-S
50 — for FNZ5□-S, MFZ50-S, and MMFZ50-S



● Element (for air filter)

E-□FNZ

Body size

30 — for FNZ30 (filtered particle size 5 μm)
40 — for FNZ40 (filtered particle size 5 μm)
50 — for FNZ50 (filtered particle size 5 μm)
31 — for FNZ31 (filtered particle size 40 μm)
41 — for FNZ41 (filtered particle size 40 μm)
51 — for FNZ51 (filtered particle size 40 μm)

The top and bottom plastic parts and the element part are separate structures.

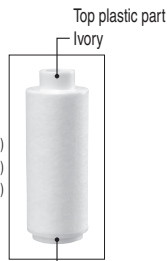

Color of bottom plastic part
Ivory (filtered particle size 5 μm)
Grey (filtered particle size 40 μm)

● Element (for oil mist filter)

E-□MFZ

Body size

30 — for MFZ30
40 — for MFZ40
50 — for MFZ50
* Filtered particle size 0.3 μm

The top and bottom plastic parts and the element part form one integrated structure.

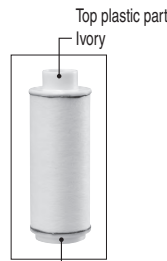

Color of bottom plastic part
Ivory

● Element (for micro oil mist filter)

E-□MMFZ

Body size

30 — for MMFZ30
40 — for MMFZ40
50 — for MMFZ50
* Filtered particle size 0.01 μm

The top and bottom plastic parts and the element part form one integrated structure.

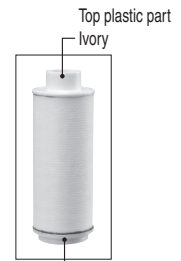

Color of bottom plastic part
Grey

● Seal kit (various o-rings)

SRK-MFZ□

Body size

30 — for FNZ3□, MFZ30, and MMFZ30
40 — for FNZ4□, MFZ40, and MMFZ40
50 — for FNZ5□, MFZ50, and MMFZ50

Refer to "Replacing the seal kit, element, and bowl assembly" on page 16 regarding the component parts of the seal kits.

Limited Warranty

KOGANEI CORP. warrants its products to be free from defects in material and workmanship subject to the following provisions.

Warranty Period The warranty period is 180 days from the date of delivery.

Koganei Responsibility If a defect in material or workmanship is found during the warranty period, KOGANEI CORP. will replace any part proved defective under normal use free of charge and will provide the service necessary to replace such a part.

Limitations

- This warranty is in lieu of all other warranties, expressed or implied, and is limited to the original cost of the product and shall not include any transportation fee, the cost of installation or any liability for direct, indirect or consequential damage or delay resulting from the defects.

- KOGANEI CORP. shall in no way be liable or responsible for injuries or damage to persons or property arising out of the use or operation of the manufacturer's product.

- This warranty shall be void if the engineered safety devices are removed, made inoperative or not periodically checked for proper functioning.

- Any operation beyond the rated capacity, any improper use or application, or any improper installation of the product, or any substitution upon it with parts not furnished or approved by KOGANEI CORP., shall void this warranty.

- This warranty covers only such items supplied by KOGANEI CORP. The products of other manufacturers are covered only by such warranties made by those original manufacturers, even though such items may have been included as the components.

The specifications are subject to change without notice.

URL <http://www.koganei.co.jp>

E-mail: overseas@koganei.co.jp



KOGANEI CORPORATION

OVERSEAS DEPARTMENT

3-11-28, Midori-cho, Koganei City, Tokyo 184-8533, Japan
Tel: 81-42-383-7271 Fax: 81-42-383-7276

KOGANEI INTERNATIONAL AMERICA, INC.

39300 Civic Center Dr., Suite 280, Fremont, CA 94538, U.S.A.
Tel : 1-510-744-1626 Fax : 1-510-744-1676

SHANGHAI KOGANEI INTERNATIONAL TRADING CORPORATION

Room 2606-2607, Tongda Venture Building No.1, Lane 600, Tianshan Road,
Shanghai, 200051, China
Tel: 86-21-6145-7313 Fax: 86-21-6145-7323

TAIWAN KOGANEI TRADING CO., LTD.

Rm. 2, 13F, No88, Sec. 2, Zhongxiao E. Rd., Zhongzheng Dist., Taipei City 100,
Taiwan (ROC)
Tel: 886-2-2393-2717 Fax: 886-2-2393-2719

KOGANEI KOREA CO., LTD.

6F-601, Tower Bldg., 1005, Yeongdeu-dong, Giheung-gu, Yongin-si, Gyeonggi-do,
446-908, Korea
Tel: 82-31-246-0414 Fax: 82-31-246-0415

KOGANEI (THAILAND) CO., LTD.

3300/90, Tower B, Elephant Tower, 16th Fl., Phaholyothin Road, Chomphon,
Chatuchak, Bangkok 10900, Thailand
Tel: 66-2-937-4250 Fax: 66-2-937-4254

KOGANEI ASIA PTE. LTD.

69 Ubi Road 1, #05-18 Oxley Bizhub, Singapore 408731
Tel: 65-6293-4512 Fax: 65-6293-4513