



<http://www.koganei.co.jp>



## Multi-Channel, Multi-Sensor Controller

# MSU Series



### Do you have these problems?



Are you troubled?

There are too many types of sensors (pressure, flow, etc.) inside the equipment...

Monitoring and controlling each sensor is too complicated!



Best Answer!

**1 controller centrally manages any 4 sensors with outputs of 1 to 5 V\*!**

**Plus, with the RS485 communication type, up to 16 controllers can be centrally managed! (Maximum of 64 sensor heads)**

\* Including other manufacturer's products

**NEW** Added PNP output type

RS232C communication  
RS485 communication

Connect any sensor with 1 to 5 V output

Pressure and flow sensor heads are available



5 output mode patterns

\*Only NPN type is UL compliant.

# Multi-channel multi-sensor controller **MSU Series**

## Extensive output settings can support your application!

### Output mode setting

#### • Hysteresis Mode

Mode for setting the ON point and OFF point

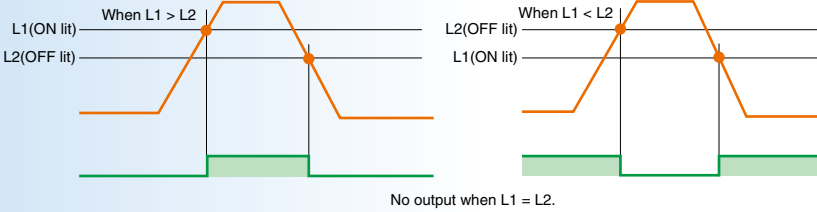

#### • Window comparator mode 1

(mode that does not turn on when between L1 and L2 while rising)  
Mode for turning output ON within the set value range for L1 and L2 (OFF point depends on response differential setting)  
Does not turn on when entering range while rising

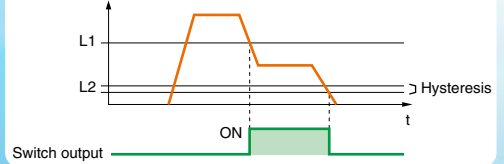

#### • Window comparator mode

Mode for turning output ON within the set value range for L1 and L2 (OFF point depends on response differential setting)

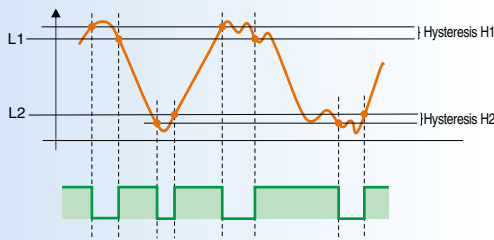

#### • High Mode

Mode for turning output ON when above the ON point (OFF point depends on response differential setting)

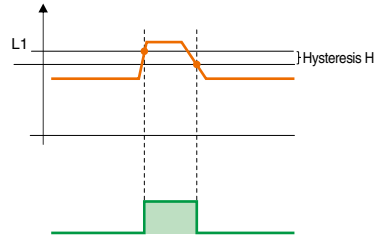

#### • Low Mode

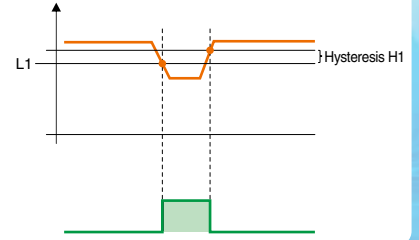

Mode for turning output ON when below the ON point (OFF point depends on response differential setting)



\* To use Window Comparator Mode 1 and Window Comparator Mode, setting must be  $L1 > L2$ .

## Any type of sensor can be connected!

### Pressure sensor head variations

Sensor head	Operating pressure range	1 kPa = 0.295 inHg
 For negative pressure MSU-PH-EA-□ MSU-PH-EA-S	-100 to 0 kPa	
 Compound pressure (for low pressure) MSU-PH-ER-□ MSU-PH-ER-S	-100 kPa to 220 kPa	
 Compound pressure (for high pressure) MSU-PH-EM-□ MSU-PH-EM-S	-100 kPa to 1000 kPa	

### Pressure sensor head options

Reducer connection type  
 $\phi 4$  [0.157]: -UR4  
 $\phi 6$  [0.236]: -UR6



Female threaded connection type  
 M5: -M5

### Flow rate sensor head variations (existing models) \*Not UL/CE compliant.

Sensor head	Operating flow range	1 l/min = 0.035 ft <sup>3</sup> /min
 FS-R3	-3 l/min to 3 l/min	
FS-R05	-500 ml/min to 500 ml/min	
FS-10	0 l/min to 10 l/min	

### Any sensor that can be connected

1 to 5 V output type  
 You can use a 1 to 5 V linear output sensor by setting the display value at 5 V and display value at 1 V.

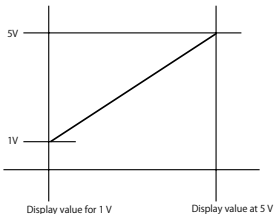



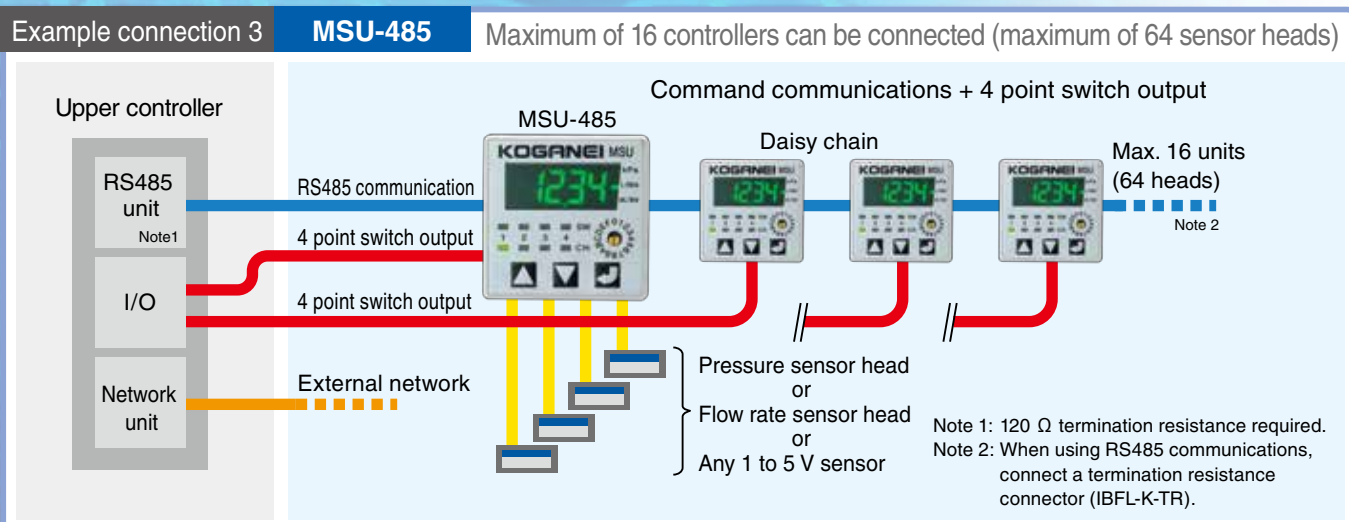
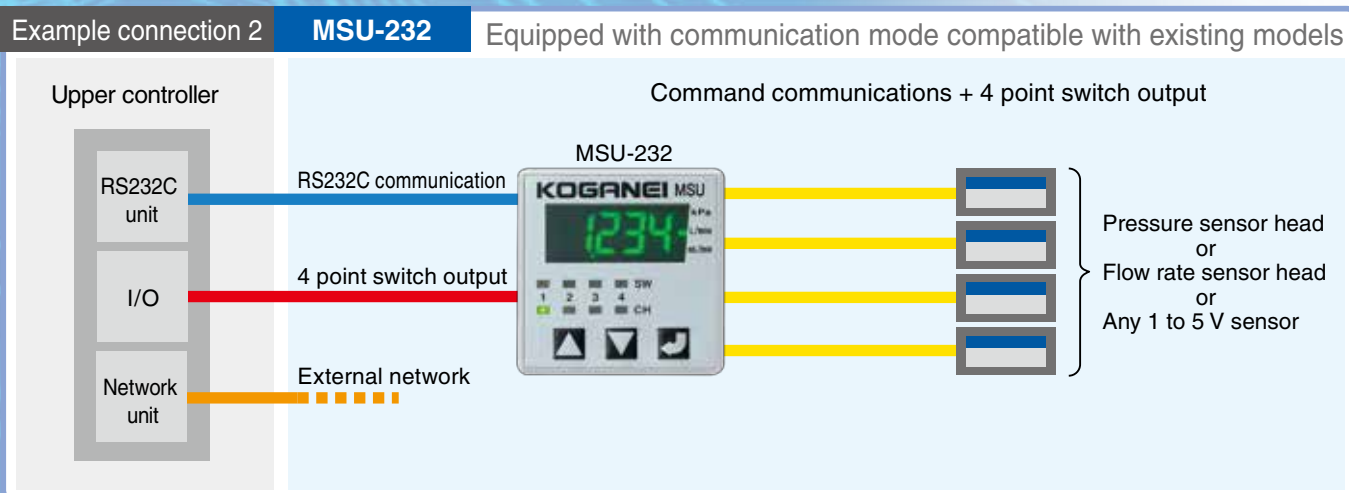
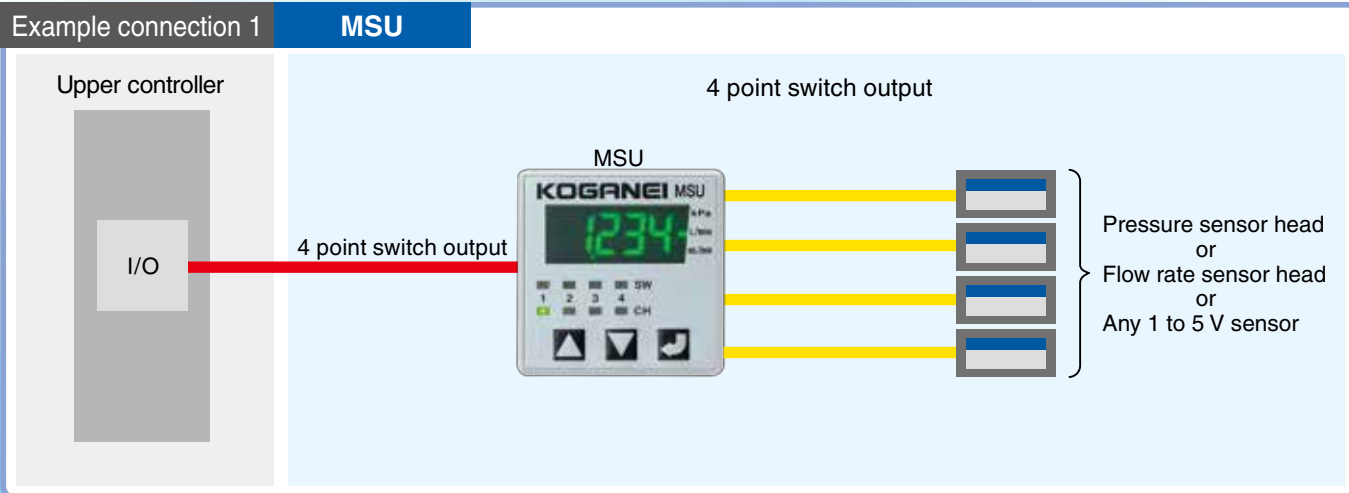

Display value for 1 V      Display value at 5 V

# 1 controller centrally manages multiple sensors!



Before selecting and using products, please read all the Safety Precautions carefully to ensure proper product use. The Safety Precautions shown below are to help you use the product safely and correctly, and to prevent injury or damage to assets beforehand. Follow the Safety Precautions in ISO4414 (Pneumatic fluid power—General rules and safety requirements for systems and their components), JIS B 8370 (Pneumatic system regulations), and other safety regulations.

The directions are ranked according to degree of potential danger or damage: "DANGER", "WARNING", "CAUTION!", and "ATTENTION!".

 <b>DANGER</b>	Expresses situations that can be clearly predicted as dangerous. If the noted danger is not avoided, it could result in death or serious injury. It could also result in damage or destruction of assets.
 <b>WARNING</b>	Expresses situations that, while not immediately dangerous, could become dangerous. If the noted danger is not avoided, it could result in death or serious injury. It could also result in damage or destruction of assets.
 <b>CAUTION</b>	Expresses situations that, while not immediately dangerous, could become dangerous. If the noted danger is not avoided, it could result in light or semi-serious injury. It could also result in damage or destruction of assets.
 <b>ATTENTION</b>	While there is little chance of injury, this content refers to points that should be observed for appropriate use of the product.

**■ This product was designed and manufactured as parts for use in General Industrial Machinery.**

- When selecting and handling equipment, the system designer or another person with sufficient knowledge and experience should always read the safety precautions, catalog, instruction manual and other literature before commencing operation. Making mistakes in handling is dangerous.
- After reading the Owner's Manual, Catalog, etc., always place them where they can be easily available for reference to users of this product.
- If transferring or lending the product to another person, always attach the Owner's Manual, Catalog, etc., to the product where they are easily visible, to ensure that the new user can use the product safely and properly.
- The danger, warning, and caution items listed under these "Safety Precautions" do not cover all possible cases. Read the Catalog and Owner's Manual carefully, and always keep safety first.

 **DANGER**

- Do not use for the applications listed below:
  1. Medical equipment related to maintenance or management of human lives or bodies.
  2. Mechanical devices or equipment designed for the purpose of moving or transporting people.
  3. Critical safety components in mechanical devices.
 This product has not been planned or designed for purposes that require advanced stages of safety. It could cause injury to human life.
- Do not use in locations where explosives, flammables, or other dangerous substances are present. This product is not an explosion-proof type unit. Explosion or ignition may occur.
- When mounting the product and workpiece, always firmly support and secure them in place. Dropping or falling the product or improper operation could result in injury.
- Never attempt to remodel the product. It could result in abnormal operation leading to injury, electric shock, fire, etc.
- Never attempt inappropriate disassembly, or assembly of the product relating to its basic inner construction, or to its performance or functions. It could result in injury, electric shock, fire, etc.
- Do not splash water on the product. Spraying it with water, washing it, or using it underwater could result in malfunction of the product leading to injury, electric shock, fire, etc.
- Do not make any adjustments (connecting or disconnecting wiring connectors, mounting or positioning sensor heads, etc.) to mechanisms attached to the product while the product is operating. This could result in abnormal operation leading to injury.

 **WARNING**

- Because Koganei products may be used under a wide variety of conditions, decisions concerning conformance with a particular system should be made upon the careful evaluation by the person in charge of system design. Assurances concerning expected system performance and safety are the responsibility of the designer who decides system conformity. Be sure to use the latest catalogs and technical materials to study and evaluate specification details, to consider the possibility of machine breakdown, and to configure a system that ensures fail-safe safety and reliability.
- Do not use the product in excess of its specification range. Doing so creates the risk of product breakdown, loss of function, or damage. It could also drastically reduce the operating life.
- Before supplying air or electricity to the device and before starting operation, always conduct a safety check of the area of machine operation. Unintentional supply of air or electricity could possibly result in injury caused by contact with moving parts.
- Do not touch the terminals and the miscellaneous switches, etc., while the device is powered on. There is a possibility of electric

shock and abnormal operation.

- Do not throw the product into fire. The product could explode and/or release toxic gases.
- Do not sit on the product, place your foot on it, or place other objects on it. Accidents such as falling could result in injury. Dropping or toppling the product may result in injury, or it might also damage or break it, resulting in abnormal or erratic operation, runaway, etc.
- Before doing maintenance inspections, repairs, or replacement of any parts, always completely cut off all air and vacuum pressure connections, and confirm that the pressure in the product and connected pipes is atmospheric pressure. In particular, be aware that pressure remains in compressors, vacuum pumps, and air tanks. The actuator may move abruptly if residual air pressure remains inside the piping, causing injury.
- Use safety circuits or system designs to prevent damage to machinery or injury to personnel when the machine is shut down due to emergency stop or electrical power failure.
- Before performing any kind of wiring work, be sure to turn off the power. Failure to do so creates the risk of electric shock.
- Do not allow lead wires and other cords to become damaged. Allowing the cords to be damaged, bent excessively, pulled, rolled up, placed under heavy objects or squeezed between two objects, may result in current leaks or defective continuity that will lead to fire, electric shock, or abnormal operation.
- Do not connect or disconnect connectors while the power is turned on. Also, never apply unnecessary force to connectors. Doing so creates the risk of personal injury, device damage, and electric shock due to abnormal machine operation.
- Always check the catalog and other reference materials for correct product wiring and piping. Improper wiring or piping causes abnormal operation of the actuator, etc.
- Use countermeasures for heat dissipation so that the ambient temperature of the product stays within the specified temperature range if the energizing time is long or if the product is installed inside a control panel. Also, contact Koganei when continuously energizing for long periods of time.
- Do not locate solenoid valves or their control wires near power lines carrying large currents, or in locations subject to strong magnetic fields or surges. It could result in unintended operation.
- Do not use the product near the ocean, in direct sunlight, near mercury vapor lamps, or near equipment that generates ozone. Deterioration of rubber parts caused by ozone may reduce performance and functions or stop functions. (except for ozone resistant products)
- Do not use any type of medium that is not specifically stipulated in the specifications. Using a non-specified medium could lead to short term loss of function, sudden degradation of performance, and a reduced operating life.
- After completing wiring work, check to make sure that all connections are correct before turning on the power.

## Safety Precautions

- Do not use the product in locations subject to direct sunlight (ultraviolet radiation); in locations subjected to high temperature or humidity; in locations where dust, salt, or iron particles are present; or in locations with media and/or an ambient atmosphere that includes organic solvents, phosphate ester type hydraulic oil, sulfur dioxide gas, chlorine gas, acids, etc. It could lead to early shutdown of some functions, a sudden degradation of performance, and a reduced operating life. For information about materials, see Major Parts and Materials.
- Do not apply an external magnetic field to the product while it is operating. Unintended operations could damage equipment or cause injury.
- Make sure that the polarity of wiring connections is correct. Incorrect polarity could result in damage to the product.
- Pressure sensor heads could be damaged by static electricity if you touch them with your hand while they are energized.

### CAUTION

- When installing the product, leave room for adequate working space around it. Failure to ensure adequate working space will make it more difficult to conduct daily inspections or maintenance, which could eventually lead to system shutdown or damage to the product.
- Do not scratch, dent, or deform the product by climbing on it, using it as a step, or placing objects on top of it. It could result in damaged or broken a product that results in operation shutdown or degraded performance.
- Always post an "operations in progress" sign for installations, adjustments, or other operations, to avoid unintentional supplying of air, electrical power, etc. Unintended power supply can cause electric shock and sudden operation, creating the risk of personal injury.
- Depending on the product, unintended operations may occur when a leakage current occurs in the control circuit. Use countermeasures for circuit leakages in the control circuit so as not to exceed the allowable leakage current values for the product's specifications.
- Use only sensor heads that satisfy the specifications of the sensor controller with multi-channel multi-sensor controllers. Using one that is outside the specifications causes erratic operation.
- Use the correct tightening torque to mount sensor heads. Over-tightening beyond the allowed tightening torque may damage the mounting threads or sensor head, etc. However, insufficient tightening torque may cause leaks or shifts in the sensor head position, resulting in unstable operation. Refer to "Instruction Manual" for the tightening torques.
- While handling multi-channel multi-sensor controllers or sensor heads, do not subject them to excessive shock (over 490 m/s<sup>2</sup> [50 G]) by hitting, dropping, or bumping them. Even if the product appears undamaged, damage to internal components can cause abnormal operation.
- Avoid short circuiting the loads. Turning a sensor's output on while the load is short-circuited causes overcurrent, which will damage the sensor head instantly. Furthermore, even with multi-channel multi-sensor controllers, turning on SW output while the load is short-circuited may damage the products due to over current. Example of short-circuit load: Output lead wire for sensor output (SW output) is directly connected to the power supply.

### ATTENTION

- When considering the possibility of using this product in situations or environments not specifically noted in the Catalog or Owner's Manual, or in applications where safety is an important requirement such as in an airplane facility, combustion equipment, leisure equipment, safety equipment, and other places where human life or assets may be greatly affected, take adequate safety precautions such as an application with enough margins for ratings and performance or failsafe measure. Be sure to consult us about such applications.
- Use a protective cover, etc., to ensure that human bodies do not come into direct contact with the operating portion of mechanical devices, etc.
- Do not control in a way that would cause workpieces to fall during power failure. Take control measures so that they prevent the workpieces, etc., from falling during power failure or emergency stop of the mechanical devices.
- When handling the product, wear protective gloves, safety glasses, safety shoes, etc., to keep safety.
- When the product can no longer be used, or is no longer necessary, dispose of it appropriately as industrial waste.
- Pneumatic equipment can exhibit degraded performance and function over its operating life. Always conduct daily inspections of the pneumatic equipment, and confirm that all requisite system functions are satisfied, to prevent accidents from happening.
- For inquiries about the product, contact your nearest Koganei sales office or Koganei overseas department. The address and telephone number is shown on the back cover of this catalog.

### Other

- Always observe the following items.
  1. When using this product in pneumatic systems, always use genuine Koganei parts or compatible parts (recommended parts). When doing maintenance or repairs, always use genuine Koganei parts or compatible parts (recommended parts). Always follow the designated procedures and methods.
  2. Never do inappropriate disassembly or assembly of the product related to basic construction, performance, or functions.
  3. Sensor heads are for use with non-corrosive gas. Do not use it for liquids or corrosive gas.
  4. Check the power fluctuation to ensure that the input power does not exceed the rated value.
  5. Avoid use during the transitional state (0.5 seconds) when the power is turned on.
  6. Do not insert wires from the detection ports of the sensor heads. Doing so may damage the diaphragm and cause it to be unable to operate normally.
  7. Never use a needle or any other sharp pointed object to perform key operations.

Koganei cannot be responsible if these items are not properly observed.

### Warranty and General Disclaimer

#### 1. Warranty Period

The warranty period for Koganei products is 1 year from the date of delivery.

\* However, some products have a 2-year warranty; contact your nearest Koganei sales office or the Koganei overseas department for details.

#### 2. Scope of Warranty and General Disclaimer

- (1) When a product purchased from Koganei or from an authorized Koganei distributor or agent malfunctions during the warranty period in a way that is attributable to Koganei's responsibility, Koganei will repair or replace the product free of charge. Even if a product is still within the warranty period, its durability is determined by its operation cycles and other factors. Contact your nearest Koganei sales office or the Koganei overseas department for details.
- (2) The Koganei product warranty covers individual products. Therefore, Koganei is not responsible for incidental losses (repair of this product, various expenses required for replacement, etc.) caused by breakdown, loss of function, or loss of performance of Koganei products.
- (3) Koganei is not responsible for any losses or for any damages to other machinery caused by breakdown, loss of function, or loss of performance of Koganei products.
- (4) Koganei is not responsible for any losses due to use or storage of the product in a way that is outside of the product specifications prescribed in Koganei catalogs and instruction manuals, and/or due to actions that violate the mounting, installation, adjustment, maintenance or other safety precautions.
- (5) Koganei is not responsible for any losses caused by breakdown of the product due to factors outside the responsibility of Koganei, including but not limited to fire, natural disaster, the actions of third parties, and intentional actions or errors by the purchaser.

## Handling Instructions and Precautions



### General precautions

#### Wiring

1. When using a power supply with a commercially available switching regulator, be sure to connect a frame ground (F.G.). Use Class 2 switching regulator.
2. When using devices that generate noise (switching regulator, inverter motor, etc.) in the vicinity of the sensor installation, be sure to connect a frame ground (F.G.) to the devices.
3. After completing wiring work, check to make sure that all connections are correct.

# Handling Instructions and Precautions

## Sensor head and connector connection procedure

When the sensor head **MSU-PH-□-□** is supplied, the sensor head body and mini clamp connector (male) are not yet connected. Follow the procedure below to perform the connection.

1. Check that the connector cover (the part where lead wires are to be inserted) is protruding from the connector body.

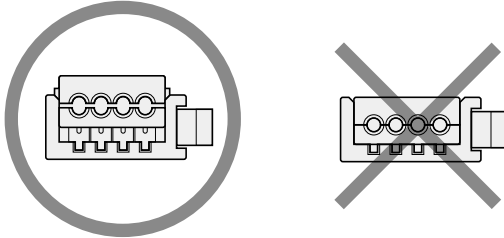

It cannot be used if it's flat and placed at the same level against the body.

2. Cut the cable at the length required for the sensor head. Strip off the cable sheath for 50 mm [1.97 in.] from the cable end, and expose the lead wires. At this time, do not take off the lead wire insulation.

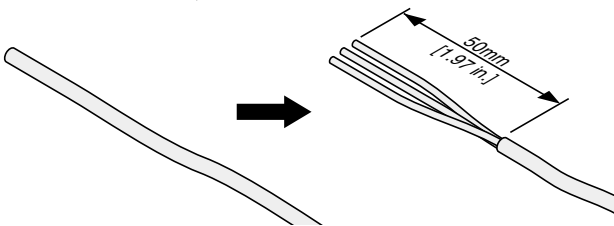

3. Follow the instructions in the table below to insert the lead wires into the hole in the connector cover. Look through the top of the semi-transparent cover to check that the lead wires have been firmly inserted all the way to the back. (Insertion length is about 9 mm [0.35 in.]) Use caution in making the connections, since switching on the power with wrong connections will damage the sensor head and controller.

No. on the connector	Signal name	Color of lead wire
1	Sensor head power supply (+)	Sensor head brown wire
2	Sensor head voltage output	Sensor head black wire
3	Sensor head power supply (0V)	Sensor head blue wire
4	Reference pressure capture	Prepared by customer AWG 24-26 (0.14-0.3sq) Insulation diameter: φ 0.8-1.0 mm [0.031-0.039 in.]

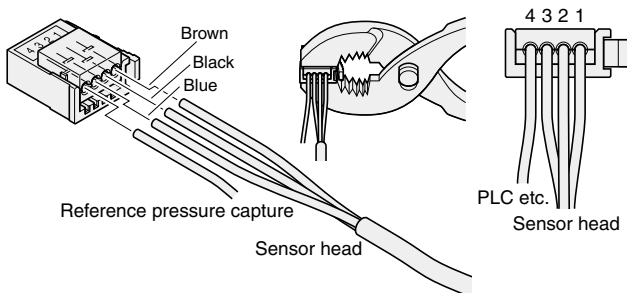

4. Taking care to avoid letting the lead wires slip out from the connector, use pliers or some other hand tool to crimp the cover and connector body, and push the cover into the connector body. Limit the crimping force to 980.7 N [220.5 lbf]. When the cover is flat and placed at the same level against the connector body, the connection is complete.
5. In the same way, handle the sensor head relay cable **PSUK-□** mini-clamp connectors (male, female).
6. Check one more time that the wiring is correct.

### Sensor head body

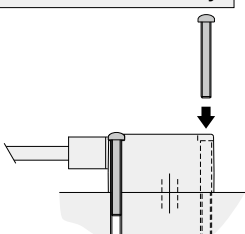

Use the small screws provided to mount the sensor head. The tightening torque should not exceed 6.0N·cm [0.53in·lbf].

## Attaching and removing of the sensor head, and the power supply, switch, and communication cable

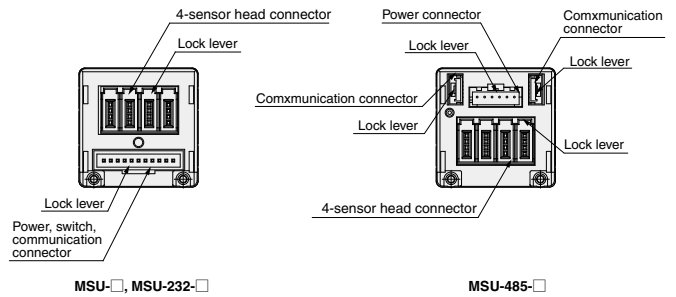

To mount the sensor head and the power supply, switch, and communication cable, align the lock lever position in the direction of the arrow as shown in the figure, and push until the lock hooks on the controller-side connector.

To remove, push down completely on the lock lever, take the connector and pull it out. At this time, be careful to avoid applying excessive force on the lead wires.

## Attaching the panel mounting parts and protective front cover

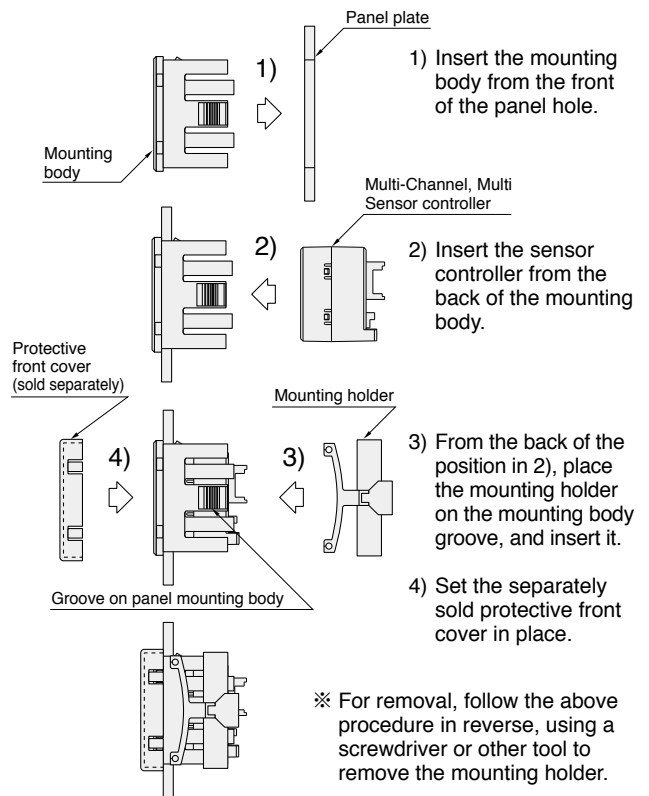

## Attaching the mounting bracket

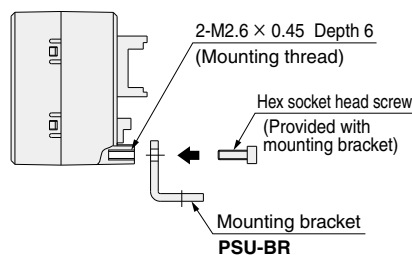

Use the hex socket head screws (M2.6×0.45, length 5 mm [0.197 in.]) to mount the mounting bracket into the mounting holes on the back of the sensor controller. The tightening torque should not exceed 32 N·cm [2.83 in·lbf].

# Specifications

## List of controller specifications

Item	Specifications	
Power supply	Voltage	12 to 24 VDC $\pm 10\%$ *Use a Class 2 power supply.
	Sensor head supply voltage	12 to 24 VDC $\pm 10\%$ (*Depending on power supply voltage)
	Consumption current	100 mA MAX. (Not including supply power to sensors)
Sensor input	Number of connected sensors	4
	Maximum consumption current for sensor head	Each channel; under 150 mA
	Input voltage range	1.0 to 5.0 VDC
	Input impedance	1 M $\Omega$
	Maximum applied voltage	5.6 V MAX.
	Compatible sensor heads	MSU-PH-EA: -101.3 to 0.0 kPa [-29.9 to 0.000 inHg] MSU-PH-ER: -100.0 to 220.0 kPa [-29.5 to 65.0 inHg] MSU-PH-EM: -100 to 1000 kPa [-29.5 to 295 inHg] FS-R05: -500 to 500 mL/min [-0.018 to 0.018 ft <sup>3</sup> /min] FS-R3: -3.00 to 3.00 L/min [-0.106 to 0.106 ft <sup>3</sup> /min] FS-10: 0.00 to 10.00 L/min [0.000 to 0.353 ft <sup>3</sup> /min] Any sensor (set display at 1 V and 5 V)
External output	Output points	4
	Output method	MSU-□ NPN open collector MSU-□-PNP PNP open collector
	Responsiveness	5 ms (when filter function is OFF)
	Load voltage	30 V MAX.
	Load current	50 mA MAX.
	Internal voltage drop	NPN: 0.3 V MAX. (when 5 mA) PNP: 2V MAX. (when 50 mA)
	Output mode	Hysteresis mode, window comparator mode 1, window comparator mode, high mode, low mode, output OFF mode
	Repeatability	1% FS
	Functions	Threshold value setting, response differential setting, output inversion, ON delay
External input	Input points	4
	Functions	Zero reset or import reference pressure
Display	Display type	LCD display
	Color	2 color display (red, green)
	Number of digits displayed	(-) 4-digit display
	Display resolution	MSU-PH-EA: 0.1 kPa [0.030 inHg] MSU-PH-ER: 0.1 kPa [0.030 inHg] MSU-PH-EM: 1 kPa [0.295 inHg] FS-R05: 1 mL/min [0.000 ft <sup>3</sup> /min] FS-R3: 0.01 L/min [0.000 ft <sup>3</sup> /min] FS-10: 0.01 L/min [0.000 ft <sup>3</sup> /min] (if more than 5.00 L/min [0.177 ft <sup>3</sup> /min], then it is 0.05 L/min [0.002 ft <sup>3</sup> /min])
	Switch output confirmation LED	Lit when external output is ON (red LED)
	Display channel confirmation LED	LED that corresponds to the currently displayed pressure lights (green LED)
	Display accuracy	1%F.S. $\pm 1$ digit (Controller stand alone)
	Functions	Auto scan, zero adjust, display update cycle, backlight setting, setting for turning LEDs off, peak-hold, bottom-hold
	Filter (Applicable to both SW output and display)	OFF to level 7

Item	Specifications		
Main unit keys	Up key: $\triangle$ Down key: $\nabla$ Enter key: $\curvearrowright$		
Communication	Communications standard	RS232C	RS485
	Communication speed	9600, 19200 bps	9600, 19200, 38400, 57600, 115200 bps
	Address settings	None	Rotary switches
	Number of daisy chain connections	Not applicable	MAX. 16
General	Operating temperature range	-10 to 50°C [14 to 122°F]; when stored: -20 to 80°C [-4 to 176°F] (non-condensation, non-freezing)	
	Operating humidity range	35 to 85% RH	
	Dielectric strength	500 VAC for 1 minute	
	Insulation resistance	100 M $\Omega$ MIN (at 500VDC megger)	
	Vibration resistance	Endurance: 10 to 55 Hz; secondary amplitude: 1.5 mm [0.059 in.], 2 hours in each direction (XYZ)	
	Shock resistance	Endurance: 490 m/s <sup>2</sup> [50 G], 5 times in each direction (XYZ) (when not electrified)	
	Materials	Surface seal: PET; case: PBT, PC; mounting screws: brass	
	Altitude	2000 m [6562 ft] or less	
	Mass	50 g [1.764 oz] (not including other optional cables)	
	Environment	Indoor use, POLLUTION DEGREE 2	
	Standard	CE, UL (Recognition)	

Note: Only NPN type is UL compliant.

## List of pressure sensor head specifications

Item	Negative pressure	Compound pressure		
Model	MSU-PH-EA	MSU-PH-ER	MSU-PH-EM	
Media	Air or non-corrosive gas			
Power supply	Voltage	24 VDC $\pm 10\%$		
	Consumption current	6 mA MAX.		
Analog output	Output voltage	1 to 5 V		
	Zero-point voltage (Vzero)	1.00 $\pm 0.05$	3.75 $\pm 0.05$	4.64 $\pm 0.05$
	Span voltage	4.00 $\pm 0.07$ (reference value)		
	Temperature characteristics	Vzero: within $\pm 30$ mV; span: within $\pm 2\%$ F.S.		
Output current	1 mA max. (load resistance of 5 k $\Omega$ or more)			
General	Operating pressure range kPa [inHg]	-101.3 to 0 [-29.9 to 0.000]	-100.0 to 220.0 [-29.5 to 65.0]	-100 to 1000 [-29.5 to 295]
	Proof pressure kPa [inHg]	900 [265.9]		1500 [443]
	Operating temperature range	0 to 50°C [32 to 122°F]; when stored: -20 to 80°C [-4 to 176°F] (when stored: humidity of less than 65% RH, atmospheric pressure)		
	Operating humidity range	35 to 85% RH		
	Insulation resistance	100 M $\Omega$ MIN (at 500VDC megger)		
	Dielectric strength	500 VAC 1 minute		
	Altitude	2000 m [6562 ft] or less		
	Environment	Indoor use, POLLUTION DEGREE 2		
	Mass	40 g [1.411 oz]		
	Standard	CE, UL (Recognition)		

Note: UL compliant when connected to NPN controller.

## Wiring specifications for the controller

<MSU-□, MSU-232-□>

### Wiring specifications

Connector type	Item	Specifications	
Made by JST B11B-XASK-1	Power supply	1 pin : 24V (red)	
		2 pin : 0V (black)	
	Switch output	3 pin : SW1 (white)	
		4 pin : SW2 (green)	
		5 pin : SW3 (yellow)	
		6 pin : SW4 (brown)	
		7 pin : 0V (black)	
	Data input and output	RS232C <sup>Note</sup>	8 pin : RXD (white)
			9 pin : TXD (red)
			10 pin : N.C
			11 pin : N.C
Made by SUMITOMO 3M 37104-3101	Data input	1 pin : +V (brown)	
		2 pin : Sensor output (black)	
		3 pin : 0V (blue)	
		4 pin : IN	

Note 1: MSU-232-□ only.

Note 2: When wiring any other sensors, the lead wire colors are different from those noted above.

<MSU-485-□>

Connector type	Item	Specifications
Manufactured by JST B6B-XASK-1	Power supply	Pin 1: 24 V (red)
		Pin 2: 0 V (black)
	Switch output	Pin 3: SW1 (white)
		Pin 4: SW2 (green)
		Pin 5: SW3 (yellow)
		Pin 6: SW4 (brown)
Manufactured by Sumitomo 3M Limited 37104-3101	Data input	Pin 1: +V (brown)
		Pin 2: sensor output (black)
		Pin 3: 0 V (blue)
		Pin 4: IN
Manufactured by JST	Data input/output RS485	Pin 1: A (white)
		Pin 2: B (pink)
		Pin 3: 0 V (yellow)
		Pin 4: N.C.
		Pin 5: N.C.

## Pressure sensor head: Characteristic tables of pressure and output

● MSU-PH-EA-□

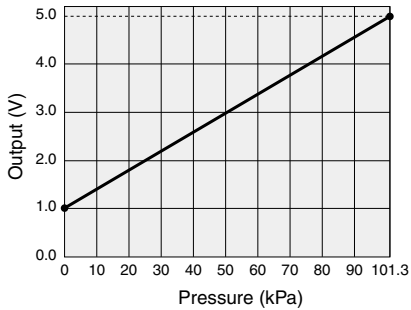

● MSU-PH-ER-□

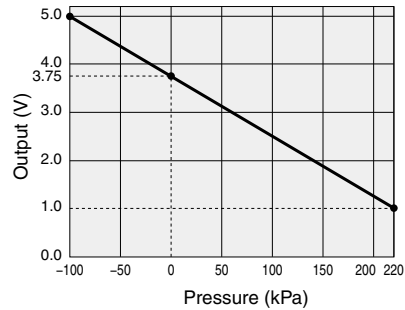

● MSU-PH-EM-□

1 kPa = 0.295 inHg

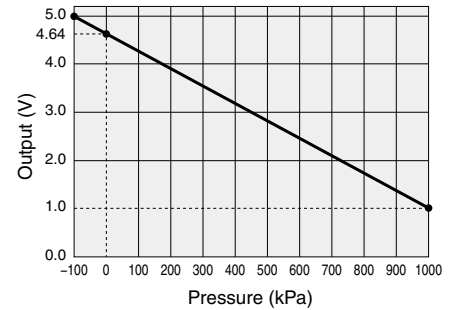



# Wiring

When connecting, refer to the figure below and use the provided power and signal cables.

## CAUTION

- In case noise generating equipment (switching regulator, inverter motor, etc.) is used in the vicinity of this sensor, connect the frame ground (F.G.) terminal of the equipment to an actual ground. Additionally, when selecting a power supply, choose one that is Class 2.
- Securely insert the connector.
- After completing wiring work, check to make sure that all connections are correct.
- Use a mechanical switch, photo coupler, or relay for external input. If the grounding potential of the external device to be used and the grounding potential of this product are different, the external device should have an insulated on/off procedure for the 0V line.
- Verify that the supply voltage variation is within the rating.

## Circuit Diagram

### <NPN output type>

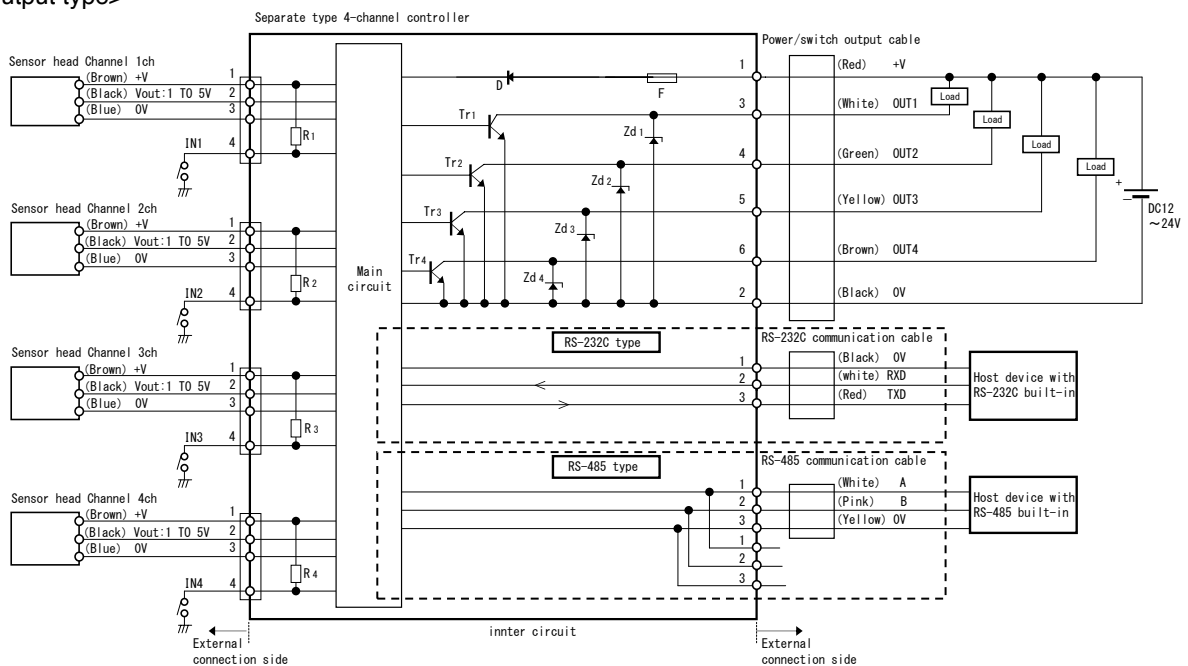

### <PNP output type>

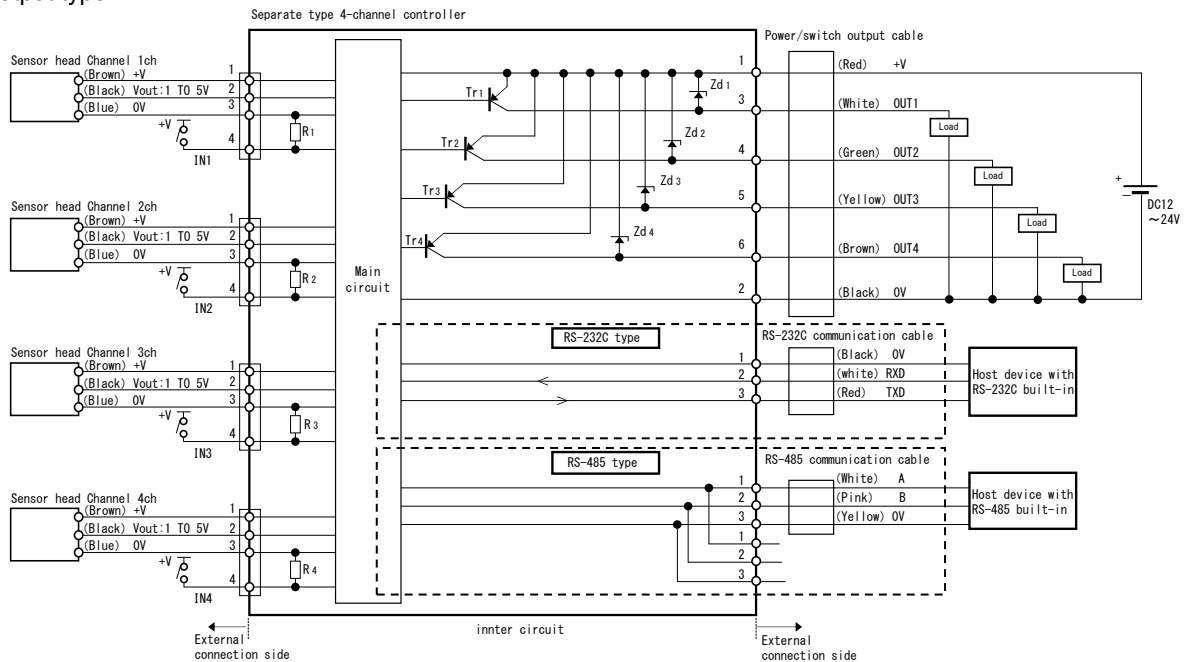

# Order Codes

## ● Sensor controller

**MSU -**  -  -  -  -

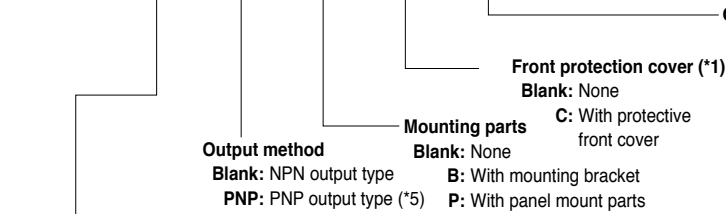

**Communication specifications**  
Blank: No communication  
232: RS232C communication  
485: RS485 communication (\*4)

- \*1) Protective front cover -C can be selected only if panel mount parts -P are selected.
- \*2) 3L and 5L can be selected only if no communication is selected  
3LD and 5LD can be selected only if -232 is selected  
3LE and 5LE can be selected only if -485 is selected
- \*3) Communication cables are sold separately. Purchase by selecting IBFL-K-□ separately.
- \*4) When using RS485 communications, be sure to connect a termination resistance connector.
- \*5) Only NPN type is UL compliant.

## ● Pressure sensor head

**MSU - PH -**  -  -

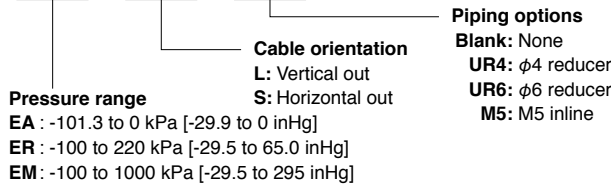

## ● Power supply/switching/communication cable

**MSU - K -**

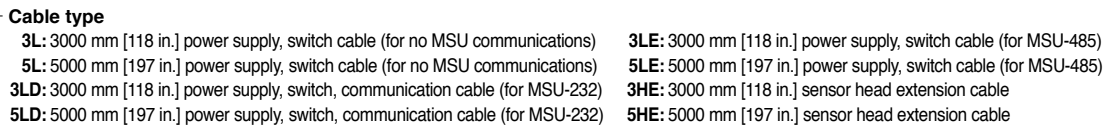

## ● Communication cable (1)

**IBFL - K -**

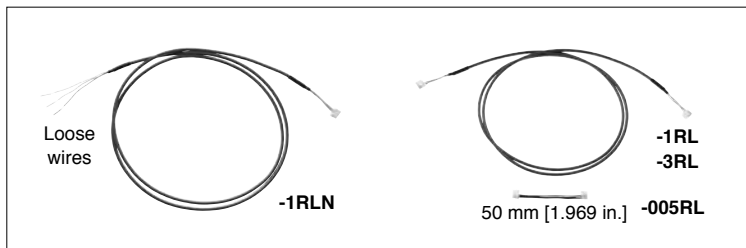
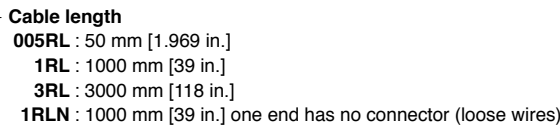

## ● USB-RS485 converter

**IBM2A - H1 -**

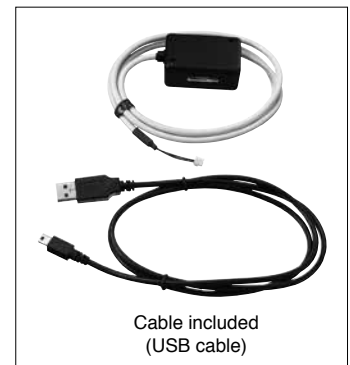
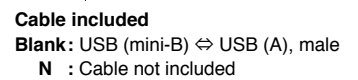

## ● Termination resistance connector

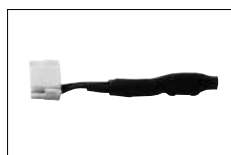

**IBFL-K-TR**

\*When using RS485 communications, be sure to connect a termination resistance connector.

● Mounting bracket  
**PSU-BR**



● Parts for panel mount  
**PM100**



● Front protection cover  
**KB100**



● Mini clamp wire mount plug  
**PSU-M**



# Dimensions (mm [in.])

## ● MSU MSU-232

No communication/RS-232C communication specification

**Enlarged diagram of wiring labels**

UL US		CE	
10 N.C.	9 TXD	1ch	SENSOR
8 RXD	7 0V	2ch	1 0V
6 0V	5 0V	3ch	2 0V
4 0V	3 0V	4ch	3 0V
2 0V	1 0V	4 IN	4 IN

\* The label above shows the MSU-232. For the MSU (no communications), 7 to 9 are N.C.  
\* Only NPN type is UL compliant.

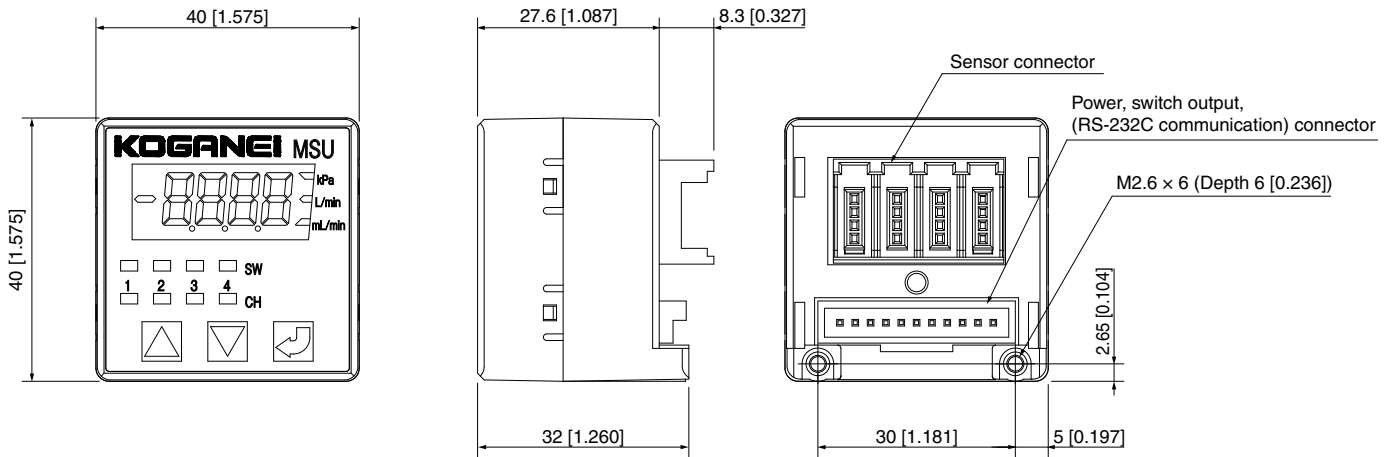

## ● MSU-485

RS-485 communication specification

**Enlarged diagram of wiring labels**

UL US		CE	
10 RS485	9 0V	1ch	SENSOR
8 0V	7 0V	2ch	1 0V
6 0V	5 0V	3ch	2 0V
4 0V	3 0V	4ch	3 0V
2 0V	1 0V	4 IN	4 IN

\* Only NPN type is UL compliant.

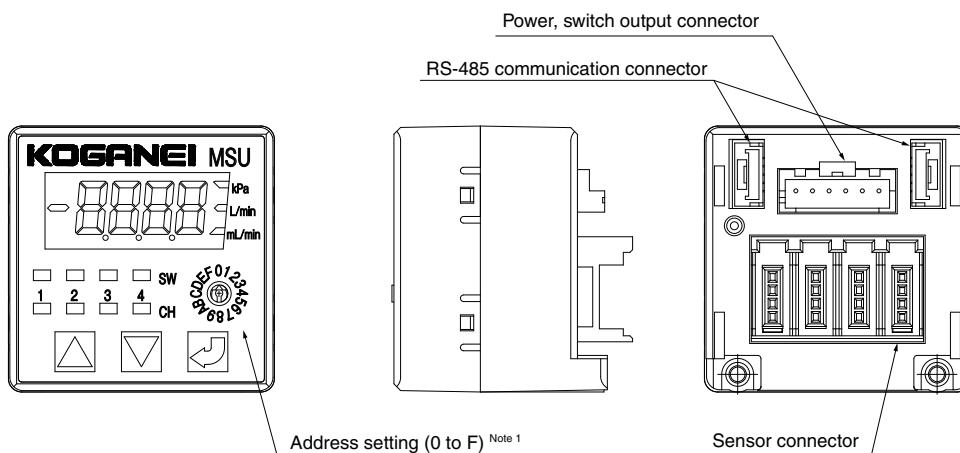

Note 1: The diagram shows when the address is 0.

● **MSU-PH-EA-L**  
**MSU-PH-ER-L**  
**MSU-PH-EM-L**

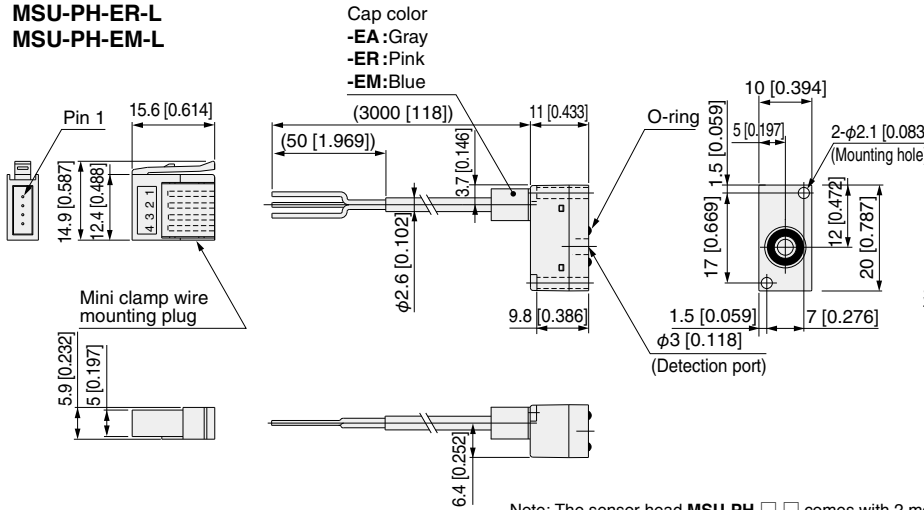

● **Sensor head mounting dimensions**  
 (For 2 pcs. mounting)  
 Surface roughness  $\nabla$ Ry6.3

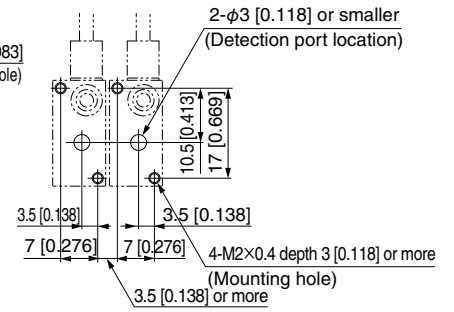

Note: The sensor head **MSU-PH-□-□** comes with 2 mounting screws (M2×0.4, length 13 [0.512]).

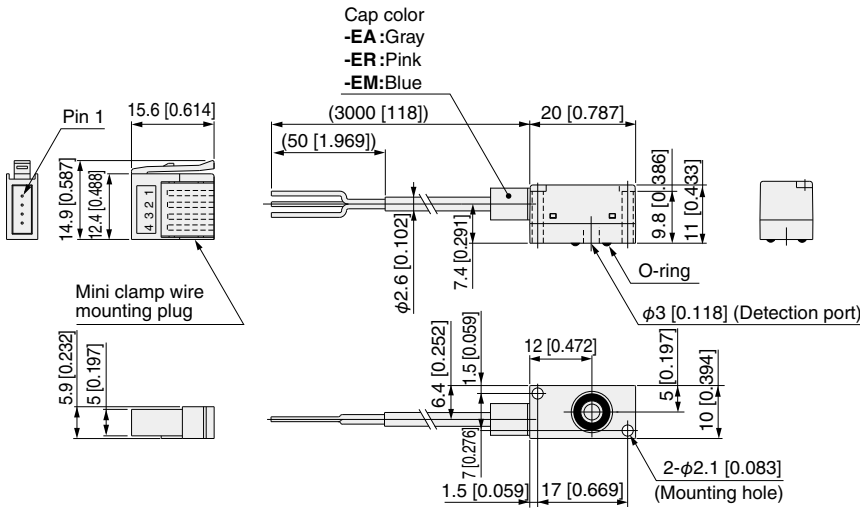

Note: The sensor head **MSU-PH-□-□** comes with 2 mounting screws (M2×0.4, length 13 [0.512]).

● **MSU-PH-EA-□-UR□**  
**MSU-PH-ER-□-UR□**  
**MSU-PH-EM-□-UR□**

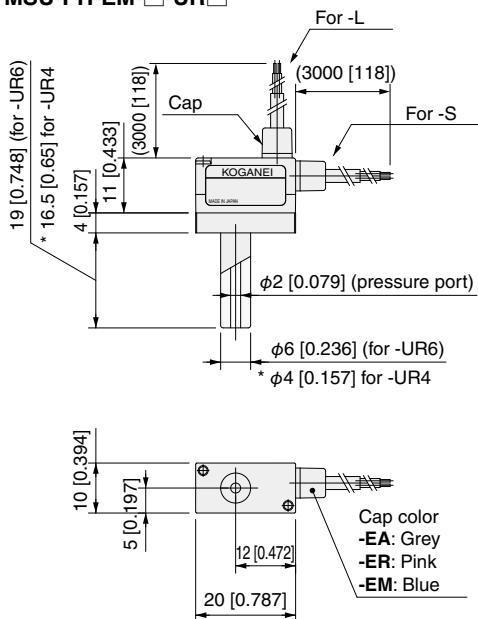

● **MSU-PH-EA-□-M5**  
**MSU-PH-ER-□-M5**  
**MSU-PH-EM-□-M5**

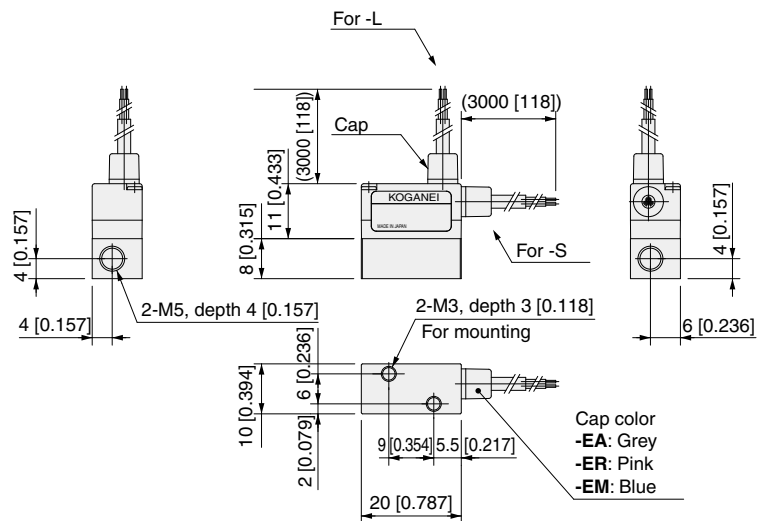

Note) -UR4 can be connected to the φ4 [0.157] quick fitting and -UR6 to the φ6 [0.236] quick fitting.

# Dimensions (mm [in.])

## ● MSU-K-□HE

Model	L
MSU-K-3HE	3000 [118]
MSU-K-5HE	5000 [197]

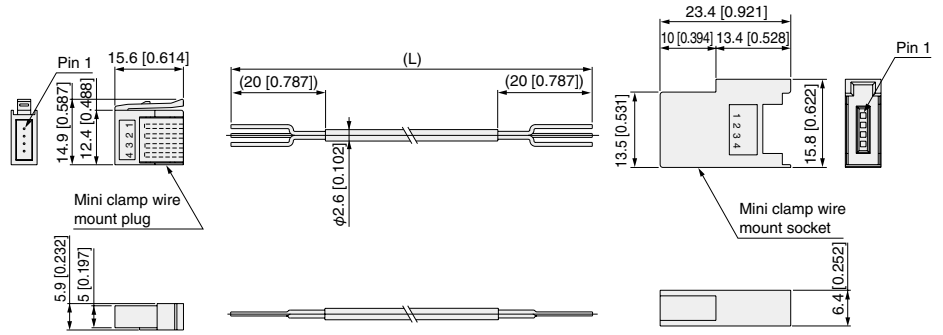

## ● MSU-K-□L MSU-K-□LD

Model	L
MSU-K-3L	3000 [118]
MSU-K-5L	5000 [197]
MSU-K-3LD	3000 [118]
MSU-K-5LD	5000 [197]

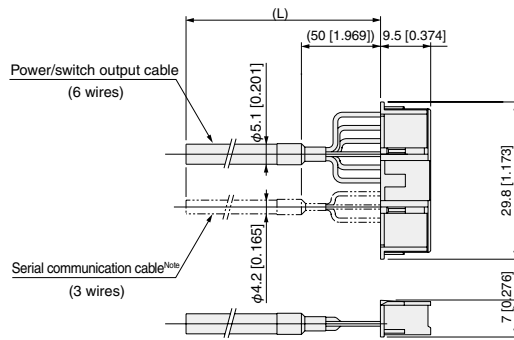

## ● MSU-K-□LE

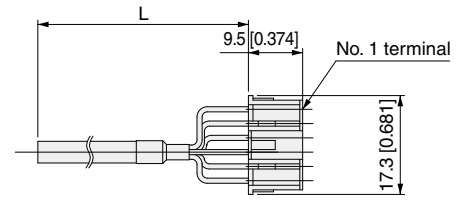

Model	L
MSU-K-3LE	3000 [118]
MSU-K-5LE	5000 [197]

## ● PSU-BR

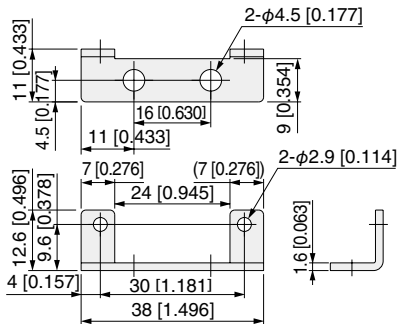

Hexagon socket head screw  
M 2.6 × 0.45 Length 5 [0.197], Two included

## ● Dimensions for drilling holes to mount the sensor controller

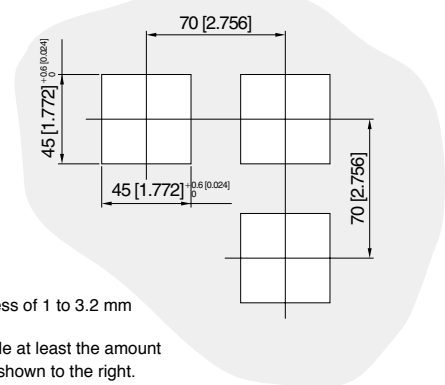

- Note 1: Use a mounting panel thickness of 1 to 3.2 mm [0.039 to 0.126 in.] mm.  
 2: For adjacent mounting, provide at least the amount of spacing between holes as shown to the right.  
 3: DIN43700 standard.

## ● MSU-□-P (installation diagram for panel mount parts)

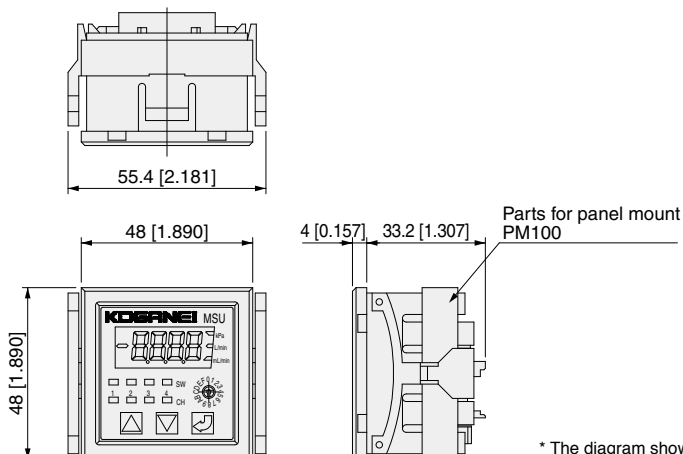

\* The diagram shows the MSU-485.

## ● KB100

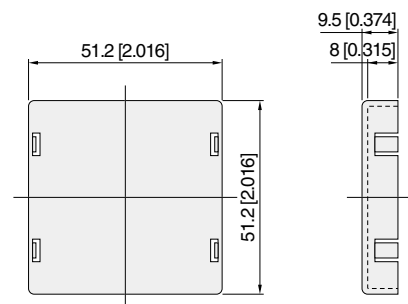

# Introduction to New Products (Separate Type Multi-Channel Flow Rate Sensor Controller Series)

## Specifications

### ● Flow rate sensor head \* Not UL/CE compliant.

Item	Model	FS-R3	FS-R05	FS-10
Measurement target gas	Air or nitrogen, however, the detected fluid must not contain any salt, sulfur, acid, or other corrosive elements. Also, air must be dry. Clean gas that does not include any dust or mist (oil mist).			
Flow rate measurement range	-3 to +3 l/min [-0.106 to +0.106 ft <sup>3</sup> /min]		-500 to +500 ml/min [-0.018 to +0.018 ft <sup>3</sup> /min]	0 to +10 l/min [0 to +0.353 ft <sup>3</sup> /min]
	Volumetric flow rate conversion value for 20°C [68°F] at 1 atm			
Responsiveness	5 ms or lower (95% response to stepped flow rate change)			
Output signal	1 to 5 VDC (non-linear characteristics); allowable load resistance: 10 kΩ or greater			
Operating temperature range	0 to 50°C [32 to 122°F] (Both ambient temperature and measured fluid temperature)			
Storage temperature range	-10 to 60°C [14 to 140°F]			
Operating/storage humidity range	10 to 80% RH (no condensation)			
Operating pressure range	-100 to +200 kPa [-29.5 to +59.1 inHg] (However, the guaranteed pressure characteristics range is -70 to +200 kPa [-20.678 to +59.1 inHg])			
Proof pressure	300 kPa [88.6 inHg]			
Output voltage accuracy	±5%FS MAX.		±5% FS MAX.	±5%FS MAX.
Standard flow rate characteristics	0.0 l/min [0.000 ft <sup>3</sup> /min]: 3.00±0.15V		0.0 l/min [0.000 ft <sup>3</sup> /min]: 3.00±0.20V	0.0 l/min [0.000 ft <sup>3</sup> /min]: 1.00±0.20V
	0.5 l/min [0.018 ft <sup>3</sup> /min]: 3.88±0.15V		0.1 l/min [0.004 ft <sup>3</sup> /min]: 3.77±0.20V	3.0 l/min [0.106 ft <sup>3</sup> /min]: 3.89±0.15V
	1.5 l/min [0.053 ft <sup>3</sup> /min]: 4.49±0.15V		0.3 l/min [0.011 ft <sup>3</sup> /min]: 4.53±0.20V	5.0 l/min [0.177 ft <sup>3</sup> /min]: 4.46±0.15V
	3.0 l/min [0.106 ft <sup>3</sup> /min]: 5.00±0.20V		0.5 l/min [0.018 ft <sup>3</sup> /min]: 5.00±0.20V	10.0 l/min [0.353 ft <sup>3</sup> /min]: 5.00±0.20V
Reproducibility	±3.5%FS MAX.		±2% FS MAX.	±6%FS MAX.
	Same conditions apply to temperature and pressure during measurement.			
Output characteristics	±0.01%FS/kPa		±0.01% FS/kPa	±0.01%FS/kPa (0 to +200 kPa [0 to +59.1 inHg])
	In -70 to +200 kPa [-20.678 to +59.1 inHg] pressure range			±0.03%FS/kPa (-70 to 0 kPa [-20.678 to 0 inHg])
Temperature characteristics	0.0 l/min [0.000 ft <sup>3</sup> /min]: ±0.1%FS/°C		0.0 l/min [0.000 ft <sup>3</sup> /min]: ±0.1% FS/°C	0.0 l/min [0.000 ft <sup>3</sup> /min]: ±0.1%FS/°C
	1.5 l/min [0.053 ft <sup>3</sup> /min]: ±0.15%FS/°C		0.3 l/min [0.011 ft <sup>3</sup> /min]: ±0.15% FS/°C	5.0 l/min [0.177 ft <sup>3</sup> /min]: ±0.2%FS/°C
Voltage	24 VDC (Supply from sensor controller)			
Allowable voltage fluctuation range	In the 21.6 to 26.4 VDC range, ±2% FS or lower relative to an output value during 24 VDC <sup>Note 2</sup>			
Output stabilization time	Time required until output is within ±5% FS of maximum voltage attained (flow rate): Instantaneous Time required until output is within ±1% FS of maximum voltage attained (flow rate): Within 10 seconds			
Consumption current	12mA MAX.			
Dielectric strength	Between all external connector terminals and the body: 500 VAC for 1 minute, or 600 VAC for one second			
Insulation resistance	Between all external connector terminals and the body: 50 MΩ (500 VDC megger)			
Connection type	M5 female thread (brass insertion); tightening torque: 2.5 N·m [22.128 in·lbf] or less			
Material	Gas contact part: PPS resin (main flow path), ceramic (substrate) brass (contacts) Cover: PC resin (polycarbonate)			
Mounting direction	Excluding directions where the cover is facing downwards.			
Mounting criteria	When using this device's mounting holes, use M3 screws, and tighten to a torque of 0.6 N·m [5.311 in·lbf] or less. A filter that captures dust and mist with a particle size of 10 μm or greater can be installed on the upstream side of this device.			
Straight piping length	Not required for both upstream and downstream.			
Vibration resistance	10 to 55 Hz; total amplitude: 1.5 mm [0.059 in]; each direction (XYZ) for two hours			
Mass	9 g [0.317 oz]			
Electric connection (Special connector)	Cable with special connector			
	Flow rate sensor head side: J.S.T. Mfg. Co., Ltd. SM03B-SRSS-G-TB Other side: J.S.T. SHR-03V-S-B (housing), SSH-003GA-P0.2 (contact)			

Note 1: The % FS shown here assumes output voltage 4 V (1 to 5 V) full scale.

2: In the vicinity of the measurement range upper limit flow rate, output fluctuation of ±1% FS (drift volume 500 seconds from flow rate stabilization) at most is generated following flow rate stabilization.

## Flow rate sensor head [flow rate] - [output characteristics] charts

### ● FS-R05

[Flow rate]-[Output] characteristics

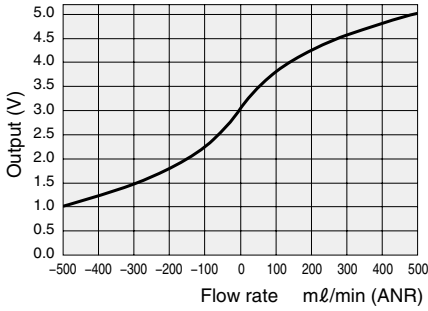

### ● FS-R3

[Flow rate]-[Output] characteristics

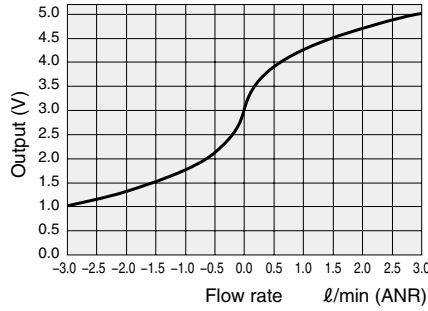

### ● FS-10

1 L/min (ANR) = 0.035 ft<sup>3</sup>/min (SCFM)

[Flow rate]-[Output] characteristics

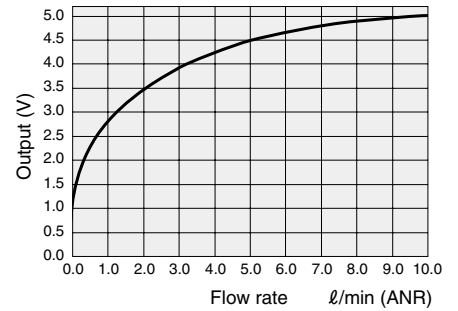

## Order Codes

### Additional Parts (available separately)

Flow rate sensor head

● FS-□

Flow rate sensor head

Flow range

**R05**: -500 to 500 mL/min(ANR)  
[-0.018 to 0.018 ft<sup>3</sup>/min(SCFM)]

**R3**: -3 to 3 L/min(ANR)  
[-0.106 to 0.106 ft<sup>3</sup>/min(SCFM)]

**10**: 0 to 10 L/min(ANR)  
[0 to 0.353 ft<sup>3</sup>/min(SCFM)]

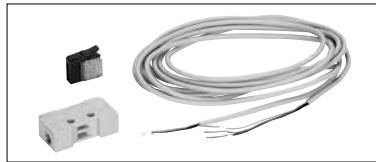

## Dimensions (mm [in.])

### ● FS-□

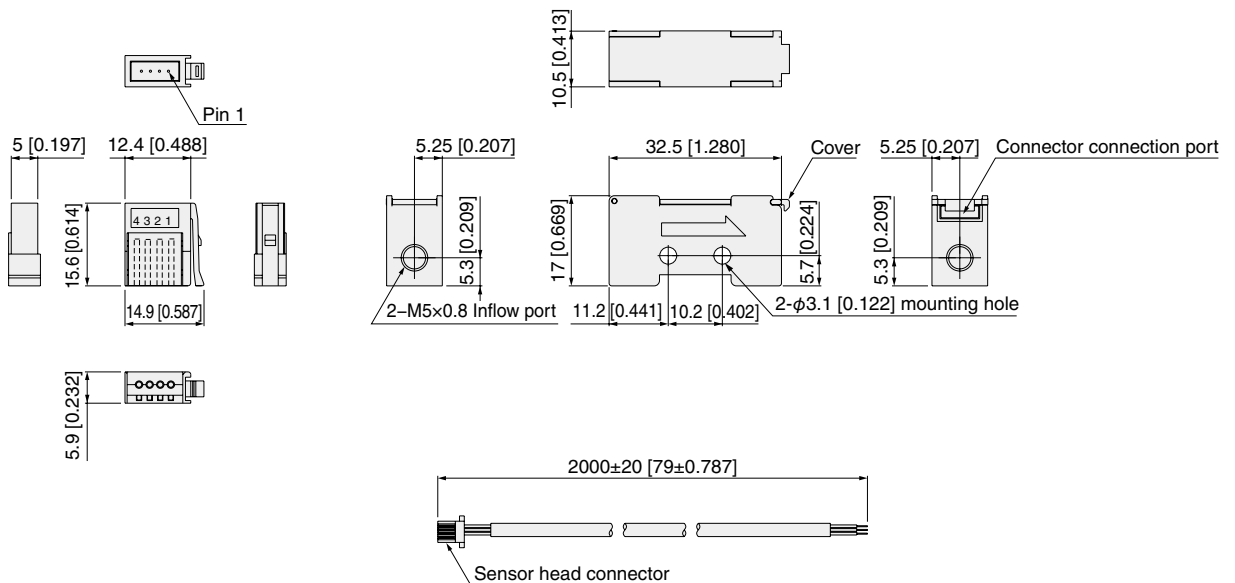

# Limited Warranty

KOGANEI CORP. warrants its products to be free from defects in material and workmanship subject to the following provisions.

**Warranty Period** The warranty period is 180 days from the date of delivery.

**Koganei Responsibility** If a defect in material or workmanship is found during the warranty period, KOGANEI CORP. will replace any part proved defective under normal use free of charge and will provide the service necessary to replace such a part.

**Limitations**

- This warranty is in lieu of all other warranties, expressed or implied, and is limited to the original cost of the product and shall not include any transportation fee, the cost of installation or any liability for direct, indirect or consequential damage or delay resulting from the defects.

- KOGANEI CORP. shall in no way be liable or responsible for injuries or damage to persons or property arising out of the use or operation of the manufacturer's product.

- This warranty shall be void if the engineered safety devices are removed, made inoperative or not periodically checked for proper functioning.

- Any operation beyond the rated capacity, any improper use or application, or any improper installation of the product, or any substitution upon it with parts not furnished or approved by KOGANEI CORP., shall void this warranty.

- This warranty covers only such items supplied by KOGANEI CORP. The products of other manufacturers are covered only by such warranties made by those original manufacturers, even though such items may have been included as the components.

The specifications are subject to change without notice.

URL <http://www.koganei.co.jp>

E-mail: [overseas@koganei.co.jp](mailto:overseas@koganei.co.jp)



## KOGANEI CORPORATION

### OVERSEAS DEPARTMENT

3-11-28, Midori-cho, Koganei City, Tokyo 184-8533, Japan  
Tel: 81-42-383-7271 Fax: 81-42-383-7276

### KOGANEI International America, Inc.

48860 Milmont Drive, Suite 108C Fremont, CA 94538, U.S.A  
TEL: (+1)510-744-1626 FAX: (+1)510-744-1676

### SHANGHAI KOGANEI INTERNATIONAL TRADING CORPORATION

RM2606-2607, Tongda Venture Building NO.1 Lane 600, Tianshan Road, Shanghai, China  
TEL: (+86)021-6145-7313 FAX: (+86)021-6145-7323

### TAIWAN KOGANEI TRADING CO., LTD

Rm.2, 16F., No88, Sec.2, Zhongxiao E. Rd., ZhongZheng Dist., Taipei City 10050, Taiwan (ROC)  
TEL: (+886)02-2393-2717 FAX: (+886)02-2393-2719

### KOGANEI KOREA CO., LTD

A-3001, Heungdeok IT Valley Bldg., Heungkeok 1-ro, 13, Giheung-gu, Yongin-si, Gyeonggi-do,  
446-908, KOREA  
TEL: (+82)31-246-0414 FAX: (+82)31-246-0415

### KOGANEI (THAILAND) CO., LTD

555 Rasa Tower I, Unit 1207, 1202, 12th floor, Phaholyothin Road, Chatuchak, Chatuchak,  
Bangkok 10900 Thailand  
TEL: (+66)02-513-1228 FAX: (+66)02-513-1232

### KOGANEI ASIA PTE. LTD.

69 Ubi Road 1, #05-18 Oxley Bizhub Singapore 408731  
TEL: (+65)6293-4512 FAX: (+65)6293-4513