

ION WIPER that incorporates a high-frequency AC type Ionizer and a built-in air curtain to maintain workplace cleanliness, along with highly efficient removing static electricity, dust removal, and dust collection in a single unit box.

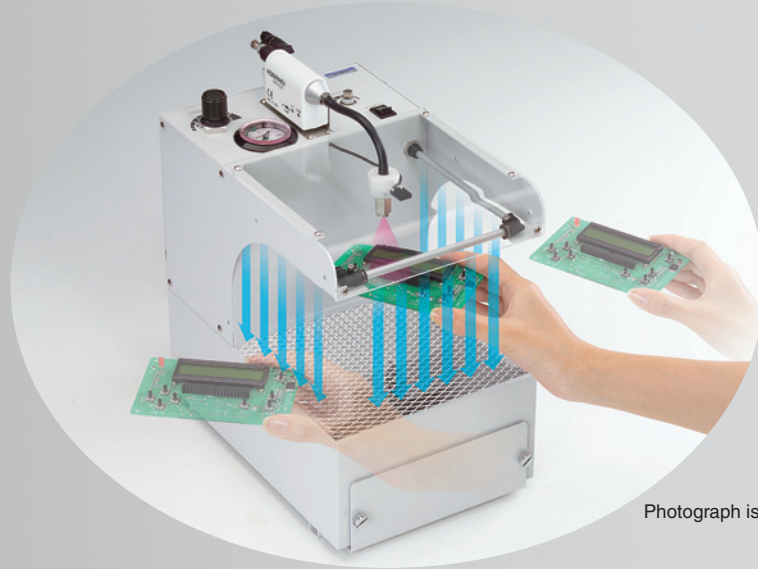

Photograph is for image purposes only.

Creceed ION WIPER

Three powerful functions (removing static electricity, dust removal, dust collection) in a single unit

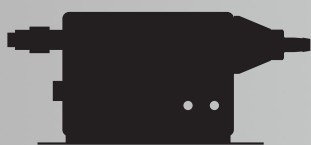

High-frequency AC "Ionizer"
Compact blow type

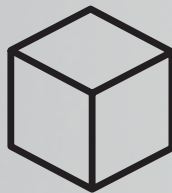

ONE UNIT BOX

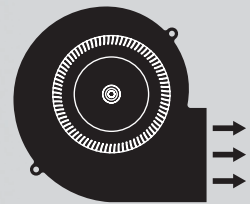

Dust collection mechanism

ION WIPER merits

By high-pressure blower
Static and dust re-adhering to workpiece



By high-frequency AC ionizer
Optimum charge removal stops dust from re-adhering!

Dust removal by blower



After Ion blowing air curtain prevents dust from scattering in the surrounding area!

Work process space savings



A4-size and A3-size installation areas are perfect for cellular production!

Better work efficiency (time)



Removing the side cover allows in-line use!

A4•A3 Desktop Clean Unit



ION WIPER prevents defects before they have a chance to occur due to electrical charges and dust adhering LCD, molded plastic, electronic, and other components. This model provides charge removal, dust removal and a dust collection box in a new design. This small box configuration improves workspace economy and work efficiency, as well as quality and productivity.

An air curtain inside the box creates a local clean

A4-size type that's perfect for cellular production

Regulator for Ionizer

Set pressure range: 0.05 to 0.5 MPa [7 to 73 psi]

Pressure gauge

For Ionizer

Ionizer Compact Blow type

(DTRY-ELL01)

Throttle valve (flow adjustment)

For air curtain

Power switch

Photoelectric switch (workpiece loading confirmation sensor)

Shower nozzle (ion air outlet)

Ion air blower blows off dust that adheres due to static electricity.

Curtain pipe (for air curtain)^{Note}

Note: Not Ion air.

Transparent anti-static cover

In-line use can also be enabled by removing the side covers from both sides.

Photoelectric switch (workpiece loading confirmation sensor)

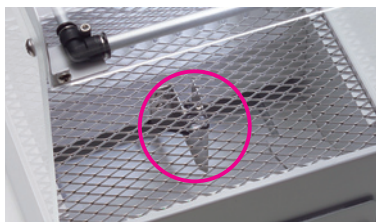

Workpiece receptacle

Even if small components fall through, they can be retrieved from the workpiece receptacle.

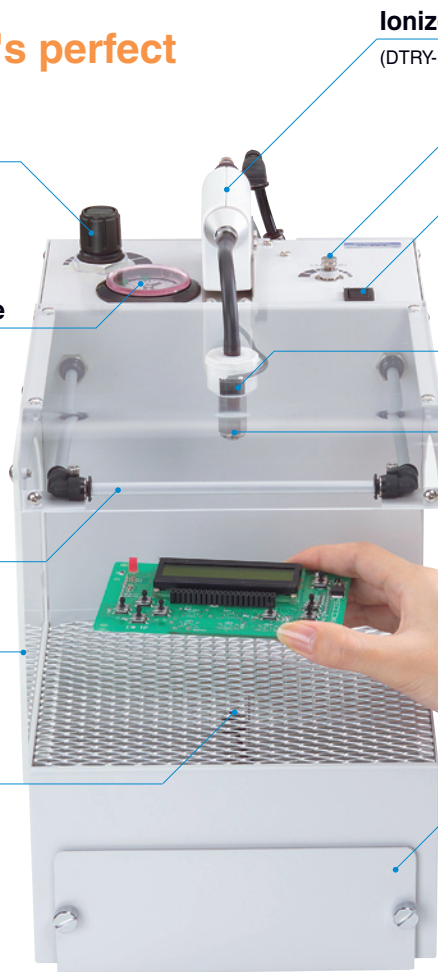

High Performance

Static electricity removing unit "Ionizers"

These static electricity removing unit "ionizers", which boast a history of performance and reliability, are also available in blow, fan, air gun, and other types. A high-frequency AC system (68,000 Hz) produces outstanding ion generation balance and stability. Low output voltage of approximately 2 kV virtually eliminates noise. (EN55011: Satisfies 1998 Group1 Class A.)



Compact

Perfect for desktop operation

200 mm [7.9 in] wide, 285 mm [11.2 in] deep, 333 mm [13.1 in] high A4-size type ion wiper. Installation of a single unit reduces charge removal and dust removal equipment running costs and production costs, while saving work process space. Perfect for allowing a single operator to perform cellular production within a desktop space. An ion wiper that creates the production facility of the future, today.

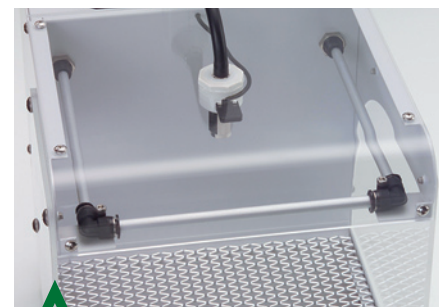

Air Curtain

Supports in-line production

Insertion of a workpiece activates an air curtain at the top of the box front and sides, which isolates the interior from the work site. This eliminates worries about dust scattering after blowing. Transparent anti-static covers on the sides provides good visibility during operations when required. The side covers can be removed for an in-line setup for even better operational efficiency time.

environment without scattering of post-blow dust.

Ion balance^{Note}

± 15v

Charge removal performance^{Note}

1000V → 100V **1 sec** (0.5 MPa [72 psi], 50 mm [1.969 in])

Note: Under Koganei measurement conditions.

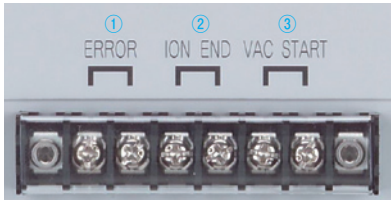

Output terminal (No-voltage a contact 24 VDC 2 A max)

- ① **ERROR** (Emergency stop)
Conduction when there is an Ion wiper error stop.
- ② **ION END** (ionizer operation ended)
Conduction for about 0.2 seconds when ion air blower is ended. Can be used for an operation count or other process management.
- ③ **VAC START** (external device operation)
Conduction during the period from workpiece insertion to process end. Can be used to sync operation with an external dust collection device, etc.

Ari IN port (φ8 mm [0.315 in] quick fitting)



Throttle valve (flow adjustment)

For Ionizer

Ionizer operating time switch

Can be used to select one of three settings (1 second, 2 seconds, continuous) to suit the workpiece.

Reset button

This button can be used to reset after an error stop.

Exhaust duct

Exhaust outlet for collected dirt. The piping port outside diameter is φ76.3 mm [3.004 in] (recommended exhaust host nominal diameter: φ75 mm [2.953 in]). If you have a dust collector, select the type without blower fan.

- Built-in dust collection blower fan type
(A4-size type: DTY-WCM-S; A3-size type: DTY-WCM-L)
- Without blower fan
(A4-size type: DTY-WC-S; A3-size type: DTY-WC-L)

Ion wiper

Ion wiper operation steps

Inserting a workpiece sequentially executes each function.

Operation sequence

- ① **Workpiece insertion** ● Dust collection blower fan start
(External device operation signal ON)
- ② **Air curtain operation** ↓↓↓↓
- ③ **Ionizer operation** ✨ Select from among: 1 second, 2 seconds, continuous
(Error signal and stop when an ion wiper abnormality occurs.)
- ④ **Ionizer stop** ● Ionizer operation end signal
output for approximately 0.2 seconds
- ⑤ **Air curtain stop**
- ⑥ **Blower stop** ● Dust collection blower fan stop
(External device operation signal OFF)
- ⑦ **Workpiece removal** ● Charge removal and dust removal operation end

* For details about operation steps, refer to page 56.

A3-size type that's perfect for large workpieces



Two ionizers built into a unit with an installation area of 400 (W) × 366 (D) [15.7 (W) × 14.4 (D)], which is just about A3-size.



Examples of ion wiper uses

● Charge removal of various types of substrates

- Charge removal



A4 type

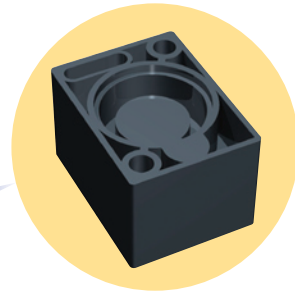

● Charge removal and dust removal from molded plastic components. Removal of dirt and other foreign matter following deburring.

● Example of in-line use. Ion wiper can be placed in a conveyor or other setting for component charge removal and dust removal.

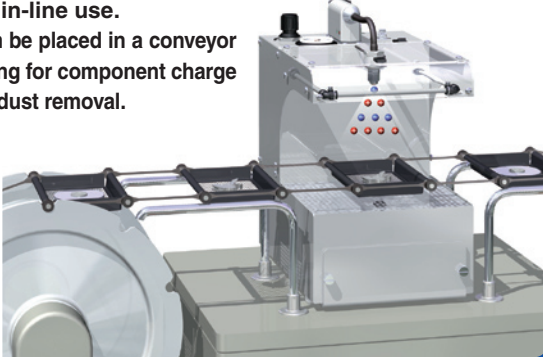

A4 type

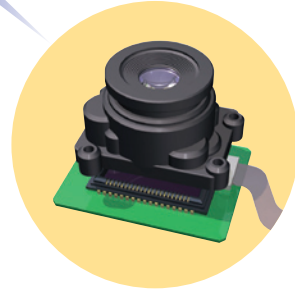

● Charge removal and dust removal from digital camera lens units, etc.

● Charge removal and dust removal from meter panels, etc.

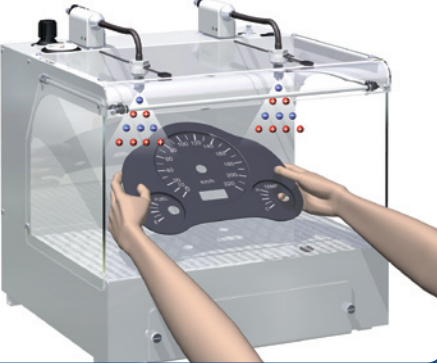

A3 type

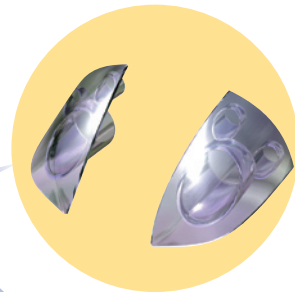

● Charge removal and dust removal from resin covers, lamp covers, etc.

● Charge removal and dust removal from mobile phone and other product assemblies. Two ionized air outlets enable removal from two units at the same time.

Note: The left and right ionizers start and stop operation simultaneously.



A3 type

Operation can also be performed with both side covers removed.

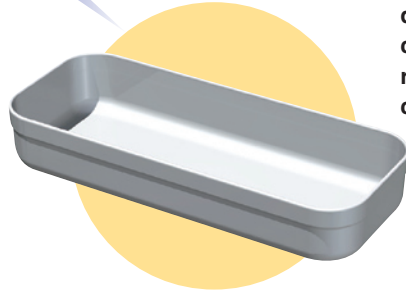

● Charge removal and dust removal from a comparatively wide range of resin cases, etc.

Ion wiper operation steps explained

Operation Example: Ionizer operation time setting: 2 seconds. Dust removal blower built-in type.

Inserting a workpiece executes each function in the sequence illustrated below.

* Steps ① to ④ (Sensor detection → Blower operation → Air curtain operation → Ionizer operation start) are executed in approximately 0.5 seconds.

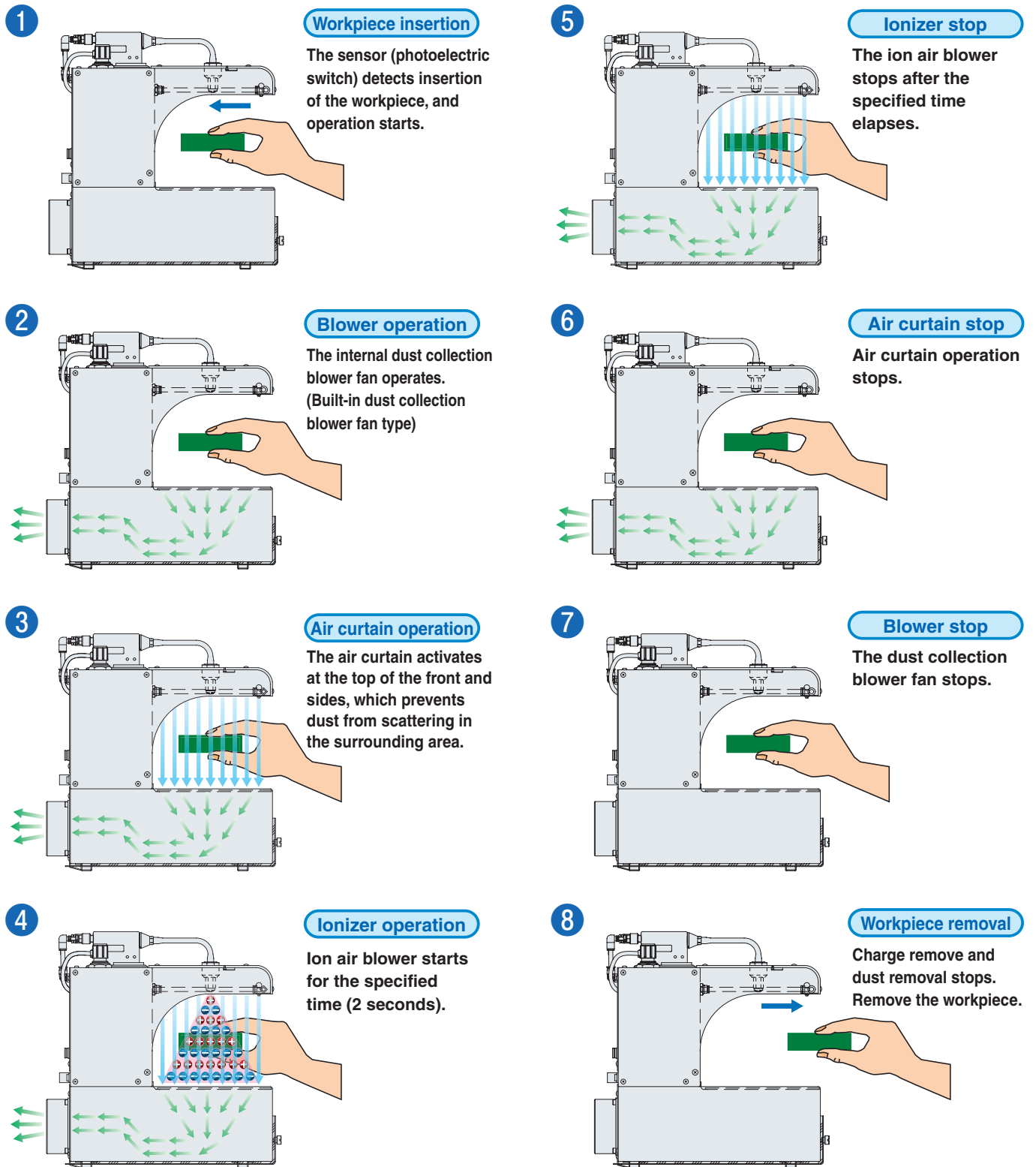

DTY-WC-S (Without blower fan)

DTY-WCM-S (Built-in dust collection blower fan type)



Specifications

Model	DTY-WC-S	DTY-WCM-S
Blower fan	None	Built in
Power supply	100 VAC ±10% (50/60 Hz)	
Consumption current	mA	Approx. 650
		Approx. 700
Built-in ionizer	DTRY-ELL01 (1 unit)	
Ion balance ^{Note}	V	±15
Media	Air	
Decay time ^{Note}	1sec(1000V→100V, 0.5 MPa [73 psi], 50 mm [1.969 in])	
Operating pressure range	MPa [psi]	0.2 to 0.7 [29 to 102]
Ionizer set pressure range	MPa [psi]	0.05 to 0.5 [7 to 73]
Port size	mm [in]	φ8 [0.315] Quick fitting
Ionizer operating time (switch)	1s, 2s, continuous	
External output	ERROR (emergency stop)	No-voltage a contact (24 VDC, 2 A max)
	ION END (ionizer operation ended)	No-voltage a contact (24 VDC, 2 A max)
	VAC START (external device operation)	No-voltage a contact (24 VDC, 2 A max)
Mass	kg [lb]	6.7 [14.771]
		7.3 [16.094]
Other	Ionizer error stop function (with reset button)	

Note: Values measured under Koganei measurement conditions. Values are not guaranteed values.

Dimensions (mm [in])

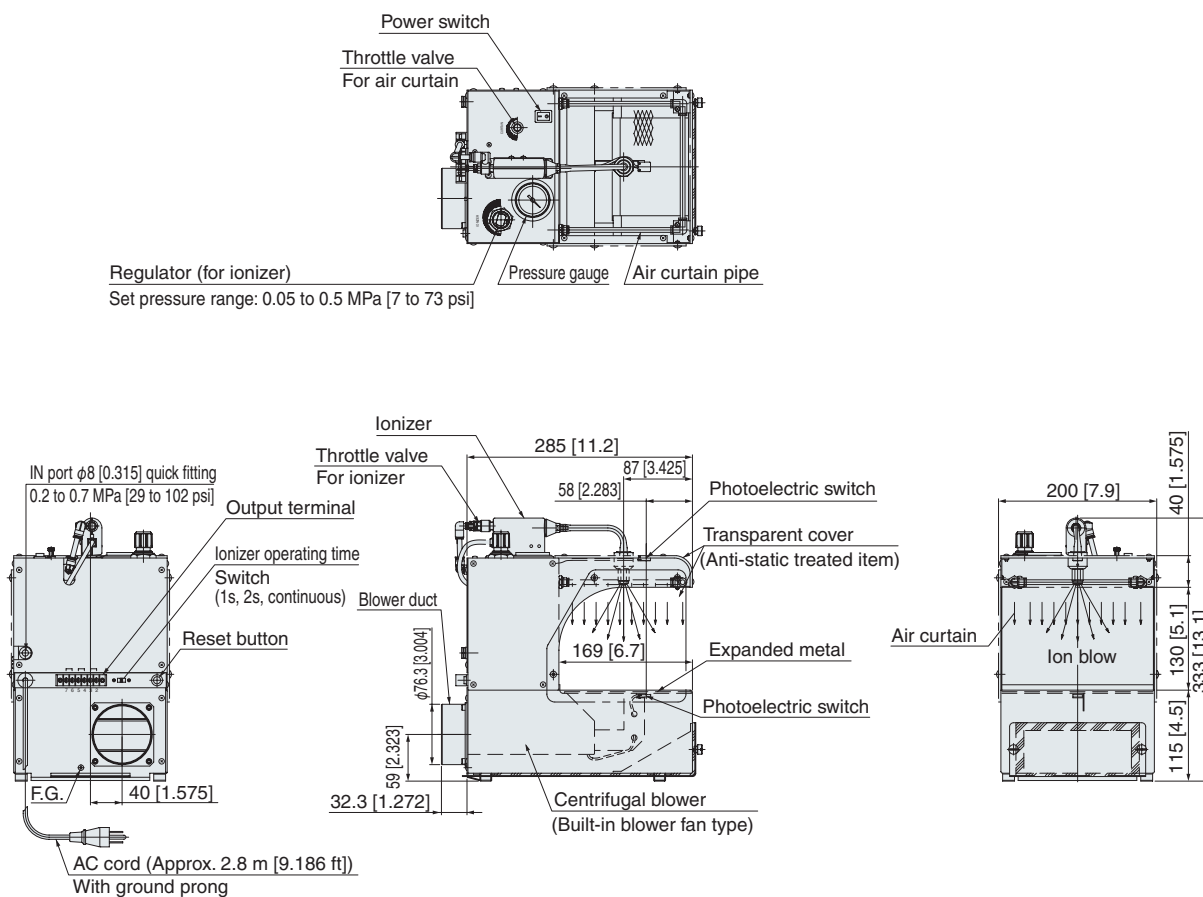

DTY-WC-L (Without blower fan)

DTY-WCM-L (Built-in dust collection blower fan type)



Specifications

Model	DTY-WC-L	DTY-WCM-L
Blower fan	None	Built in
Power supply	100 VAC ±10% (50/60 Hz)	
Consumption current	mA	Approx. 600
Built-in ionizer	DTRY-ELL01 (2 units)	
Ion balance ^{Note}	V	±15
Media	Air	
Decay time ^{Note}	1sec(1000V→100V, 0.5 Mpa [73 psi], 50 mm [1.969 in])	
Operating pressure range	MPa [psi]	0.2 to 0.7 [29 to 102]
Ionizer set pressure range	MPa [psi]	0.05 to 0.5 [7 to 73]
Port size	mm [in]	φ8 [0.315] Quick fitting
Ionizer operating time (switch)	1s, 2s, continuous	
External output	ERROR (emergency stop)	No-voltage a contact (24 VDC, 2 A max)
	ION END (ionizer operation ended)	No-voltage a contact (24 VDC, 2 A max)
	VAC START (external device operation)	No-voltage a contact (24 VDC, 2 A max)
Mass	kg [lb]	13.9 [30.644]
Other	Ionizer error stop function (with reset button)	

Note: Values measured under Koganei measurement conditions. Values are not guaranteed values.

Dimensions ((mm [in]))

