

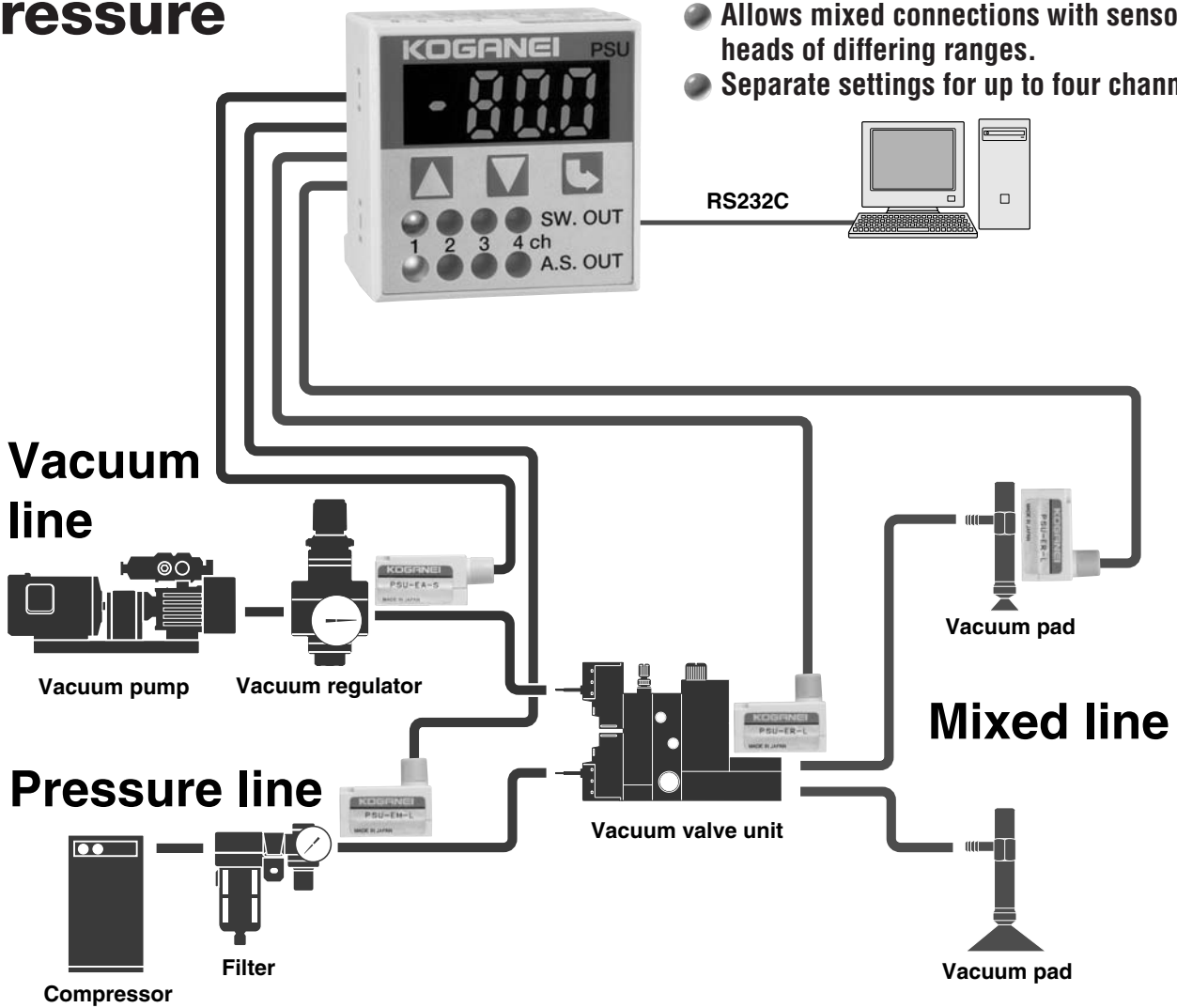





Multi-channel Pressure Sensor Controllers

Broad coverage, from negative to positive pressure

- **Connectable to a PC**
Adjust pressure settings, capture pressure values, and adjust reference pressure settings from a PC.
- **One controller can detect up to four points at the same time.**
- **Allows mixed connections with sensor heads of differing ranges.**
- **Separate settings for up to four channels.**



Three types of sensor heads

Sensor heads	Operating pressure range				
	-100	0	100	200	1000 (kPa)
 For negative pressure PSU-EA-□					
 Coupled pressure (For low pressure) PSU-ER-□					
 Coupled pressure (For high pressure) PSU-EM-□					

100 kPa=14.5 psi.

Have you ever had trouble detecting whether or not ultra-small workpieces have been picked up?

The Multi-channel Pressure Sensor Controllers come equipped with a hysteresis mode for response to ultra-small pressure differentials.

Output mode

● Hysteresis mode 1

- General mode for setting the ON and OFF points at any value desired.

● Hysteresis mode 2, Hysteresis mode 3

- Modes for response to small pressure differentials that use the ΔP setting and the reference pressure input to automatically set the ON point (ON point = Reference pressure $- |\Delta P|$). Useful for detecting the picking of ultra-small workpieces when the pressure differential for before and after picking up work is extremely small.

- **Hysteresis mode 2:** Mode that leaves the ON point unchanged from its setting until the next time that the reference pressure is re-input.

- **Hysteresis mode 3:** Mode that cancels the ON point each time the switch output is turned off, which means that, each time, the reference pressure must be given and the ON point reset.

(Most effective for situations where the reference pressure point is undergoing sudden and large changes.)

If using Hysteresis mode 3, use an RS232C or other connection to capture the reference pressure from outside.

● Time chart

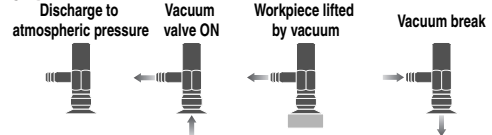

Hysteresis mode 1

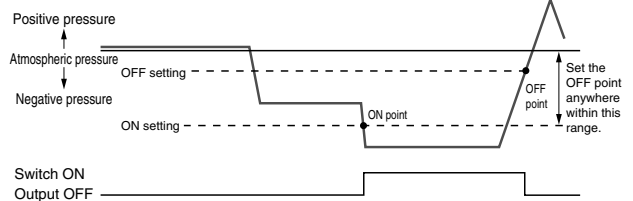

Hysteresis mode 2 Hysteresis mode 3

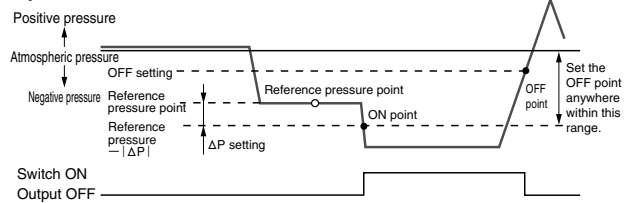

Sensor heads available in horizontal and vertical connections



With color caps for identification



Application example

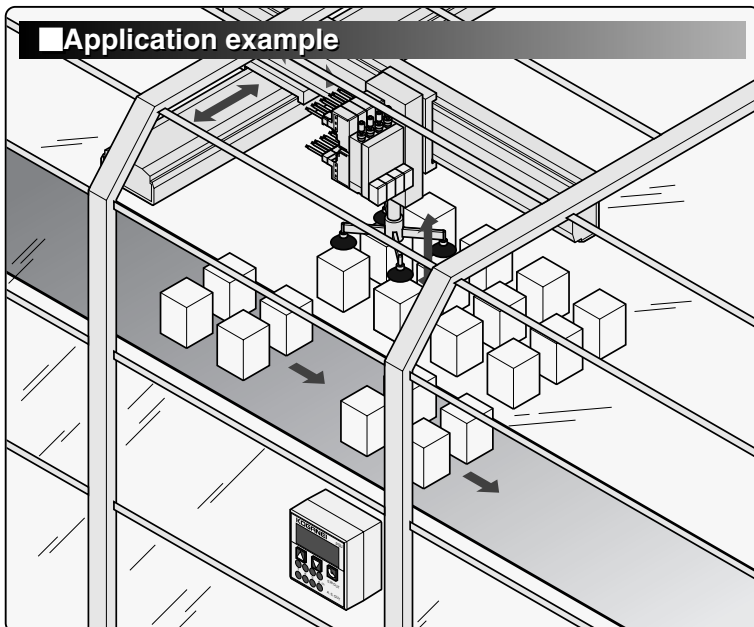

Example of mounting on outside of framework

Safety Precautions (Multi-channel Pressure Sensor Controllers)

Listed below are safety precautions specifically for the Multi-channel Pressure Sensor Controllers. For general safety precautions, be sure to read p.49.

Danger

- Never perform adjustment on mechanisms (connection or disconnection of wiring connectors, mounting or positioning of sensor heads, etc.) attached to the product while it is in operation. Abnormal operation could result in personal injury.

Warning

- Do not subject the controller or sensor head to an external magnetic field during operation of the Multi-channel Pressure Sensor Controller. It could lead to unintentional operation that could result in damage to equipment or in personal injury.
- Be careful to avoid reverse wiring polarities when performing wiring work.
A mistake could result in damage to the Multi-channel Pressure Sensor Controller.

Caution

- Always use the specified sensor head for this product.
Use of a non-specified sensor head could result in erratic operation.
- Follow the tightening torque of sensor switches when mounting.
Over-tightening beyond the allowable tightening torque may damage the mounting screws, and sensor heads. In addition, insufficient tightening torque could cause the sensor head to slip its position and/or cause leakage, resulting in operating instability. For the tightening torques, see p.784.
- When handling the Multi-channel Pressure Sensor Controller or sensor head, do not strike, drop, bump or otherwise subject them to excessive force (490 m/s^2 [50 G] or more). Even if the Multi-channel Pressure Sensor Controller or sensor head is not damaged, the interior of the sensor head or Multi-channel Pressure Sensor Controller could still be damaged, and erratic operation occur.
- Do not short-circuit the load.
Turning on the sensor switch with the shorted load will damage the Multi-channel Pressure Sensor Controller instantly due to excessive current.
An example of load short-circuit: Connecting the sensor's output lead wire directly to the power supply.

Handling Instructions and Precautions



General precautions

Wiring

1. If using a commercial switching regulator for the power source, always ground it with a frame ground (F.G.) terminal.
2. When using equipment that could be sources of noise (such as switch regulators, inverter motors, etc.) around the sensor mounting area, ground them with an equipment's frame ground (F.G.) terminal.
3. After completing all wiring, be sure to check for no error in the wiring connections.

Others

1. The sensor head is for use with non-corrosive gases. Do not use with corrosive gases or fluid.
2. Check power fluctuations to ensure that power input does not exceed the rating.
3. Avoid using the power while it is in a transient state (about 0.5 sec.) immediately after the power supply has been switched ON.
4. Never insert wires, etc., through the sensor head detection port. The diaphragm could be damaged, resulting in failure of normal operation.
5. Do not use needle tips or other sharp objects to operate the keys.



Mounting and wiring

Sensor head and connector connection procedure

When the sensor head **PSU-□-□** is supplied, the sensor head body and mini clamp connector (male) are not yet connected. Follow the procedure below to perform the connection.

1. Check that the connector cover (the part where lead wires are to be inserted) is protruding from the connector body.

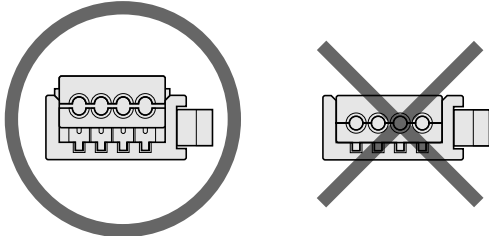

It cannot be used if it's flat and placed at the same level against the body.

2. Cut the cable at the length required for the sensor head. Strip off the cable sheath for 50 mm [1.97 in.] from the cable end, and expose the lead wires. At this time, do not take off the lead wire insulation.

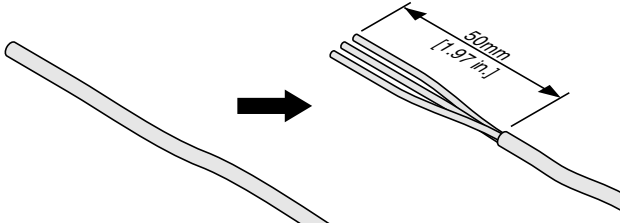

3. Follow the instructions in the table below to insert the lead wires into the hole in the connector cover. Look through the top of the semi-transparent cover to check that the lead wires have been firmly inserted all the way to the back. (Insertion length is about 9 mm [0.35 in.]) Use caution in making the connections, since switching on the power with wrong connections will damage the sensor head and controller.

No. on the connector	Signal name	Color of lead wire
1	Sensor head power supply (+)	Sensor head brown wire
2	Sensor head voltage output	Sensor head black wire
3	Sensor head power supply (0V)	Sensor head blue wire
4	Reference pressure capture	Prepared by customer AWG 24-26 (0.14-0.3sq) Insulation diameter: φ 0.8-1.0 mm [0.031-0.039 in.]

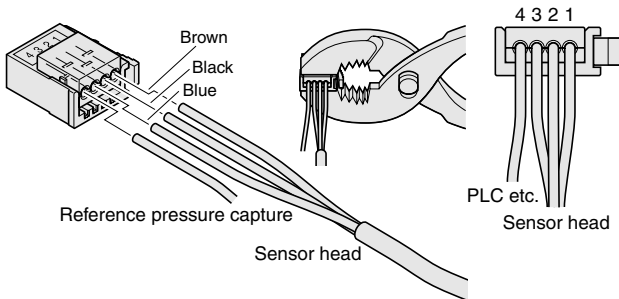

4. Taking care to avoid letting the lead wires slip out from the connector, use pliers or some other hand tool to crimp the cover and connector body, and push the cover into the connector body. Limit the crimping force to 980.7 N [220.5 lbf]. When the cover is flat and placed at the same level against the connector body, the connection is complete.
5. In the same way, handle the sensor head relay cable **PSUK-□** mini-clamp connectors (male, female).
6. Check one more time that the wiring is correct.

Sensor head body

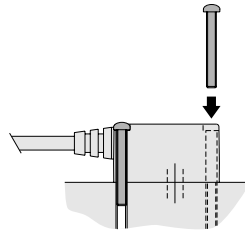

Use the small screws provided to mount the sensor head. For the mounting dimensions, see the sensor head dimensions on p.794. The tightening torque should not exceed 9.83N·cm [0.87in·lbf].

Attaching and removing of the sensor head, and the power supply, switch, and communication cable

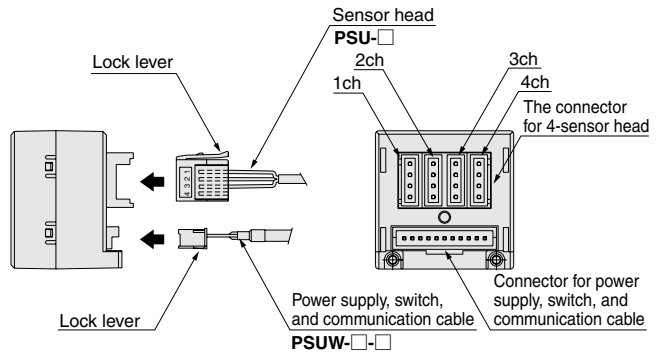

To mount the sensor head and the power supply, switch, and communication cable, align the lock lever position as shown in the figure, and push until the lock hooks on the controller-side connector.

To remove, push down completely on the lock lever, take the connector and pull it out. At this time, be careful to avoid applying excessive force on the lead wires.

Attaching the panel mounting parts and protective front cover

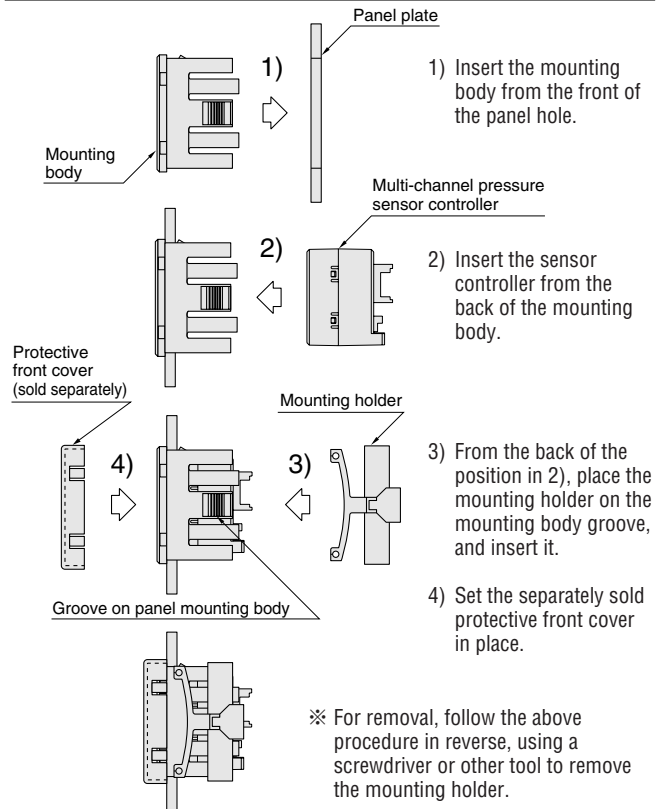

※ For removal, follow the above procedure in reverse, using a screwdriver or other tool to remove the mounting holder.

Attaching the mounting bracket

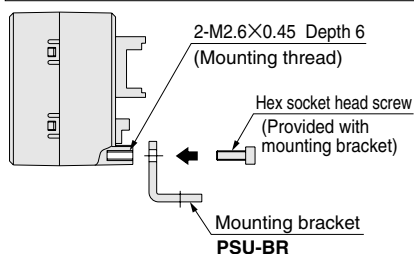

Use the hex socket head screws (M2.6×0.45, length 5 mm [0.197 in.]) to mount the mounting bracket into the mounting holes on the back of the sensor controller. The tightening torque should not exceed 32 N·cm [2.83 in·lbf].

Setting Procedure

⚠ Caution

1. Since miswiring in the sensor head, or in the power supply, switch, and communication cable, can damage both the controller and sensor head, always check the wiring before switching on the power.
2. The setting conditions are written to EEPROM and saved. Be aware that EEPROM has a finite lifetime, with guaranteed number of times up to 100,000 times.
3. Repeated input of the reference pressure while in Hysteresis 2 mode could result in the EEPROM write-ins guarantee limit being exceeded in a short period of time. Use Hysteresis 3 mode instead.
4. The explanations that follow encode Hysteresis mode 1 as HYS1, Hysteresis mode 2 as HYS2, and Hysteresis mode 3 as HYS3.

■ Major parts and functions

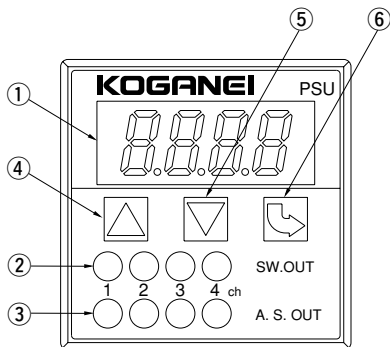

Figure 1

No.	Name	Description
①	LED display (red)	Displays the detected pressure value (kPa), setting contents, and error content
②	Switch output indicator (red)	Lights up when switch output is ON
③	Autoscan indicator (green)	The channel whose current pressure is displayed on the LED lights up
④	UP key (▲)	Used when adjusting setting value upward
⑤	DOWN key (▼)	Used when adjusting setting value downward
⑥	MODE key (⏏)	Used for all types of settings

■ Setting preparation

- Connect the connectors to the sensor heads.
(See p.784 for the connection procedure for the sensor head connectors.)
- Connect the sensor heads (one to four pcs.) and the power supply, switch, and communication cable to the controller.
(See p.784 for attaching and removing of the sensor head and the power supply, switch, and communication cable.)
- Leave the sensor head detection ports open to the air.

■ Setting procedure

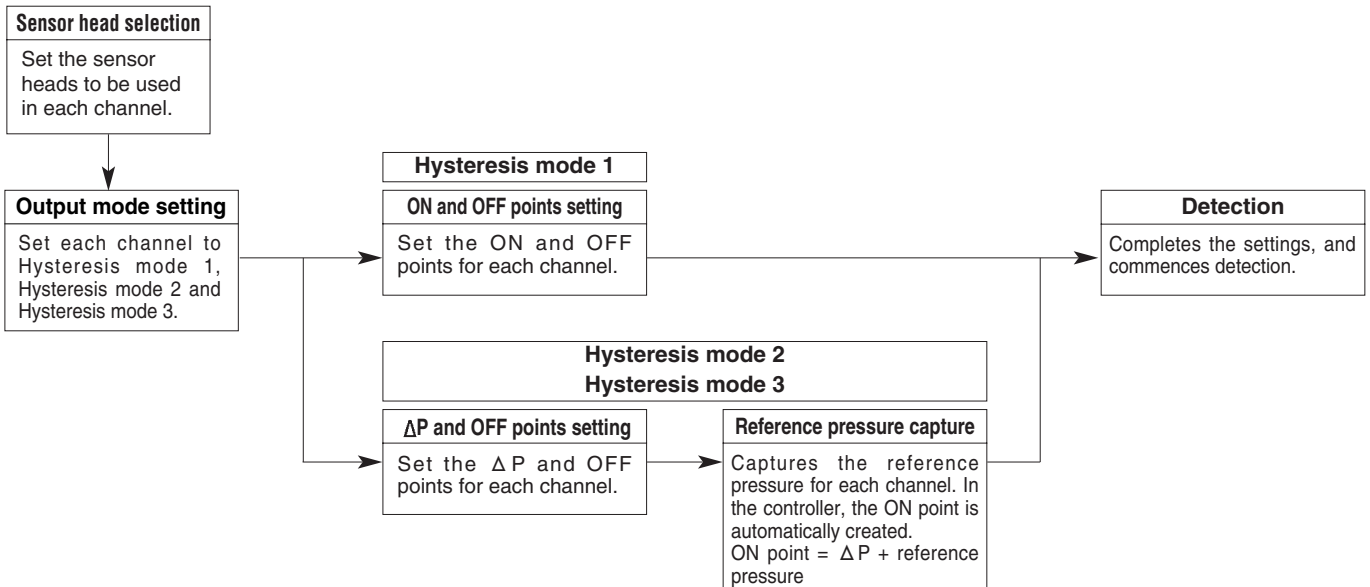

Setting

Reference pressure capture method in Hysteresis mode 2 and 3

Device key operation method	For the operations method, see p.787
RS232C method	For RS232C commands, see p.789
General-purpose I/O input method	See diagram below

Reference pressure capture method using general-purpose I/O input

Set PIN (sensor head connector 4-pin) for corresponding channel to "L level" (0.5V or less, 10 ms or longer).

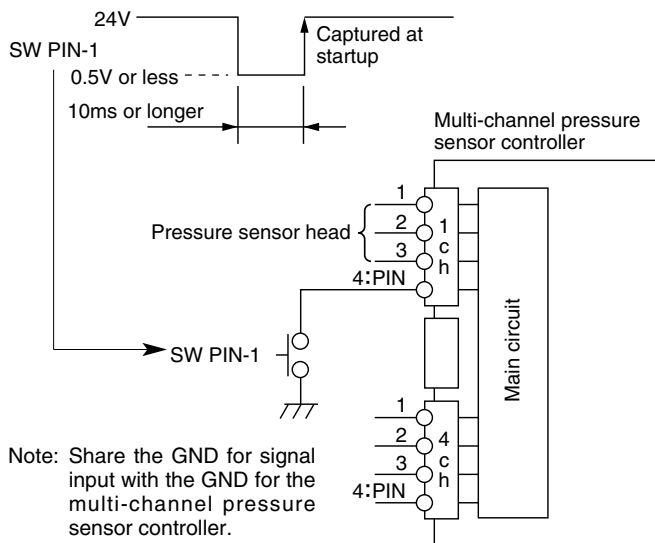

If not using general-purpose I/O input to perform reference pressure capture, do not connect anything to the PIN. (Note: PIN is pulled up at 24V.)

Functions List (For details about operations, see the each operation method)

Function	Device button command	Serial communication command (-D only)
Pressure display	○	@A
ON(ΔP)/OFF point setting	○	@PRE
Reference pressure capture	○	@P
Mode selection	○	@MODE
Sensor head type setting	○	@TYPE
Zero reset	○	@B
Pressure display autoscan	○	@AS
Peak hold	○	@PHL
Bottom hold	○	@BHL
Pressure display deleted	○	@DIS
Output mode check	×	@MD
Sensor head type check	×	@TP
ON(ΔP)/OFF point check	×	@C
Reference pressure -[ΔP]/OFF point check	×	@E (Enabled for modes 2 and 3 only)
Switch output condition display	×	@SW

Detection mode

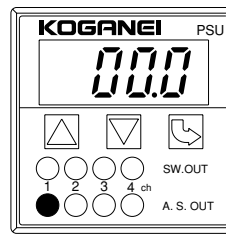

Figure 2

- Switching on the power supply (DC24V power voltage) automatically provides detection mode.
- The pressure of the selected channel is indicated in the LED display. (The selected channel's A.S.OUT LED (green) lights up. See Figure 2.)
- The SW.OUT LED (red) lights up when the switch output is turned ON.
- Pressing the \triangle key or ∇ key changes the selected channel.
- If the OFF display appears, it means that the selected channel's sensor head was not connected or has a wire break.
- In the case of a wire break, shut off the power and replace the sensor head.

Sensor head selection

Use the following procedure to perform settings for the sensor head used in each channel.

Procedure	Device operation	7-seg display	Remark
1	∇	SE1	
2	\triangle	SE2	
3	∇	SE	
4	\triangle (Push both at the same time)	CH1	Use \triangle or ∇ to select channel
5	∇	SE1	Use \triangle or ∇ to select sensor head
6	∇		Sensor head determined

[Sensor head selection]

SE1 : -101.3~0 kPa [-14.7~0 psi.] type

SE2 : -100.0~220.0 kPa [-14.5~31.9 psi.] type

SE3 : -100~1000 kPa [-14.5~145 psi.] type

Output mode selection

Use the following procedure to perform output mode settings for each channel.

Procedure	Device operation	7-seg display	Remark
1	∇	SE1	
2	∇ (Push both at the same time)	CH1	Use \triangle or ∇ to select channel
3	∇	HYS1	Use \triangle or ∇ to select output mode
4	∇		Output mode determined

[Output mode selection]

HYS1 : Hysteresis mode 1

HYS2 : Hysteresis mode 2

HYS3 : Hysteresis mode 3

Setting Procedure

Threshold value setting (ON point (ΔP)/OFF point)

Use the following procedure to perform threshold value settings for each channel.

Procedure	Device operation	7-seg display	Remark
1		SEF 1	
2		SEF	
3		11	Use or to select channel
4		***	Use or to set threshold value
5			Threshold value determined

[Threshold value setting]

11 : 1ch_ON point/ ΔP 31 : 3ch_ON point/ ΔP
 12 : 1ch_OFF point 32 : 3ch_OFF point
 21 : 2ch_ON point/ ΔP 41 : 4ch_ON point/ ΔP
 22 : 2ch_OFF point 42 : 4ch_OFF point

Reference pressure capture (for Hysteresis mode 2 and 3)

When using Hysteresis mode 2 or 3, use the following procedure to perform reference pressure capture.

Procedure	Device operation	7-seg display	Remark
1		SEF 1	
2	(Push both at the same time)	REF1	Use or to select channel
3			Reference pressure captured

[Reference pressure capture]

REF1 : 1ch REF3 : 3ch
 REF2 : 2ch REF4 : 4ch

Pressure display switch-off

Use the following procedure to shut off the pressure display.

Procedure	Device operation	7-seg display	Remark
1		SEF 1	
2		SEF 2	
3		SEF	
4	(Push both at the same time)		7-seg LED shut off
5		***	7-seg LED re-lighted

Pressure display autoscan

Use the following procedure to switch the pressure display to autoscan mode.

Since autoscan mode doubles as the key lock function, no key operation other than cancellation of autoscan can be performed.

Procedure	Device operation	7-seg display	Remark
1		SEF 1	
2		SEF 2	
3		SEF	
4	(Push both at the same time)		Autoscan start
5	(Push both at the same time)		Autoscan stop

Note: Autoscan mode is cancelled when the power supply is switched OFF.

Zero point correction (Zero reset)

Use the following procedure to perform zero point correction for each channel.

Procedure	Device operation	7-seg display	Remark
1		SEF 1	
2		SEF 2	
3		SEF 3	
4		SEF	
5	(Push both at the same time)	b-1	Use or to select channel
6			Zero point correction

Note: Zero point is cancelled when the power supply is switched OFF.

[Zero point correction]

b-1 : 1ch b-3 : 3ch
 b-2 : 2ch b-4 : 4ch

Peak hold and bottom hold

Use the following procedure to put the pressure display on peak hold or bottom hold. The display channel can be switched back and forth while in the hold position.

Procedure	Peak hold	7-seg display	Remark
1		SEF 1	
2		SEF 2	
3		SEF 3	
4		SEF	
5	(Push both at the same time)	PHL	Hold start
6	(Push both at the same time)		Hold cancel



Procedure	Bottom hold	7-seg display	Remark
1		SEF 1	
2		SEF 2	
3		SEF 3	
4		SEF	
5	(Push both at the same time)	bHL	Hold start
6	(Push both at the same time)		Hold cancel

Note: Peak hold and bottom hold are cancelled when the power supply is switched OFF.

Peak hold and bottom hold cannot be implemented at the same time.

Peak hold maintains value at the high pressure side (or low vacuum side), while bottom hold maintains value at the low pressure side (or high vacuum side).

■ Error Display

Error display	Error description	Error cancel
OFF	Sensor head on selected channel either not connected or has a wire break.	In the case of a wire break, shut off the power and replace the sensor head.
E-1	In hysteresis mode 2 or 3, threshold value is set outside the measured range.	Correct the error, and then press the mode key  for at least 1 second.
E-2  (n is the targeted channel)	Overvoltage (5V or more) applied to sensor input.	
E-3  (n is the targeted channel)	Overcurrent flowing to switch output.	

Communication

Communication with personal computer

● Hardware and operations environment

PC: PC-98 series (excluding PC-98LT) or equivalent DOS/V machine

OS: Windows95 or later

● Software and operations environment

Hyperterminal with Windows95 or later as the standard.

※Windows is a registered trademark of Microsoft Corp.

● Communication parameter

Baud rate	9600 (baud)
Stop bit length	1 [bit]
Parity	Odd
Parity check	Yes
Data bit length	8 [bit]
Communication method	Full duplex
Return key send procedure	CR code, LF code

● Communication cable specification and connection

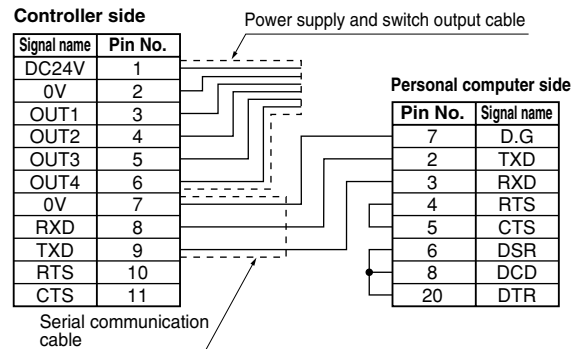

D-sub 25 pin configuration

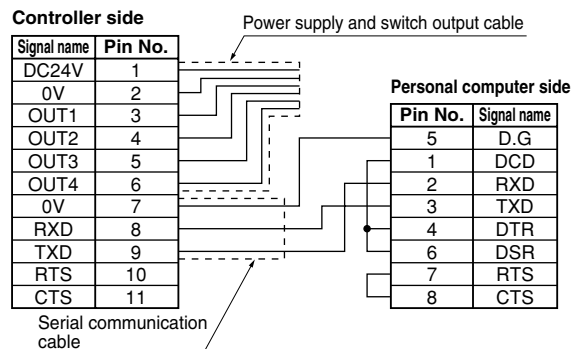

D-sub 9 pin configuration

Communication

● Communication command detail

Command List Note: “_” denotes a space.

@A

Function: Reads out the current pressure value (1ch-4ch).
 Send example: @A c/r/f
 Response example: 1 = -50.0 c/r/f
 2 = -60.0 c/r/f
 c/r/f ← When sensor head is not connected
 4 = -30.0 c/r/f
 c/r/f
 Response example: NG c/r/f
 21: illegal type

@PRE

Function: Sets the ON and OFF points for each channel.
 Send example: @PRE10_ -80.0 c/r/f
 Response example: OK c/r/f
 Response example: NG c/r/f
 21: illegal type

- @PRE10: Sets ON point/ ΔP for Channel 1
- @PRE11: Sets OFF point for Channel 1
- @PRE22: Sets ON point/ ΔP for Channel 2
- @PRE23: Sets OFF point for Channel 2
- @PRE34: Sets ON point/ ΔP for Channel 3
- @PRE35: Sets OFF point for Channel 3
- @PRE46: Sets ON point/ ΔP for Channel 4
- @PRE47: Sets OFF point for Channel 4

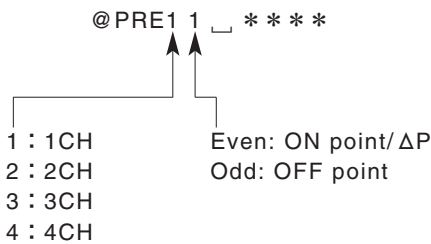

@P

Function: In output mode, the reference pressure captured when Hysteresis mode 2 or 3 is selected.
 Send example: @P1 c/r/f
 Response example: OK c/r/f
 Response example: NG c/r/f
 21: illegal type

- @P1: Captures channel 1 reference pressure
- @P2: Captures channel 2 reference pressure
- @P3: Captures channel 3 reference pressure
- @P4: Captures channel 4 reference pressure



@MODE

Function: Sets the output mode for each channel.
 Send example: @MODE1_1c/r/f
 Response example: OK c/r/f
 Response example: NG c/r/f
 21: illegal type

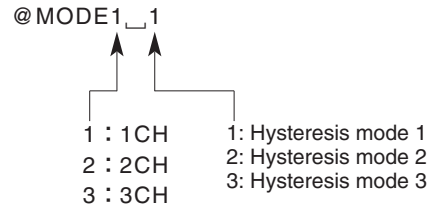

@TYPE

Function: Sets the sensor head type for each channel.
 Send example: @TYPE1_1c/r/f
 Response example: OK c/r/f
 Response example: NG c/r/f
 21: illegal type

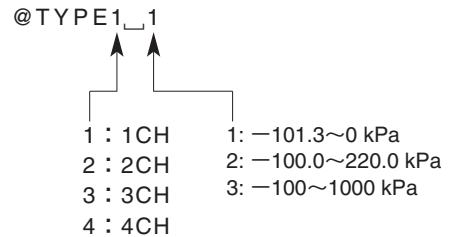

@B

Function: Performs zero correction for each channel.
 Send example: @B1 c/r/f
 Response example: OK c/r/f
 Response example: NG c/r/f
 21: illegal type



@MD

Function: Displays the output mode for each channel.
 Send example: @MD c/r/f
 Response example: 1231 c/r/f
 Response example: NG c/r/f
 21: illegal type

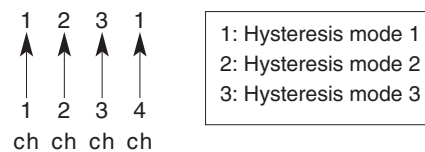

@TP

Function: Displays the sensor head type for each channel.
 Send example: @TP c/r/f
 Response example: 1132 c/r/f
 Response example: NG c/r/f
 21: illegal type

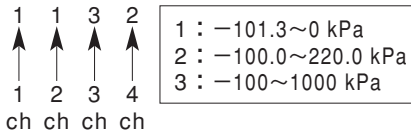

@C

Function: Displays the ON point (ΔP) and OFF point for each channel.
 Send example: @C1 c/r/f
 Response example: -70.0 c/r/f ←ON point (ΔP)
 -30.0 c/r/f ←OFF point
 c/r/f
 Response example: NG c/r/f
 21: illegal type

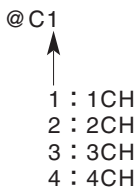

@E

Function: Displays (Reference pressure - $|\Delta P|$) and OFF point for each channel.
 Send example: @E1 c/r/f
 Response example: -70.0 c/r/f ←Reference pressure- $|\Delta P|$
 -30.0 c/r/f ←OFF point
 c/r/f
 Response example: NG c/r/f
 21: illegal type

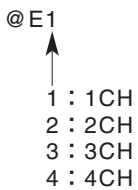

@DIS

Function: Shut off (Locks) the main unit LED.
 Send example: @DIS_1 c/r/f
 Response example: OK c/r/f
 Response example: NG c/r/f
 21: illegal type

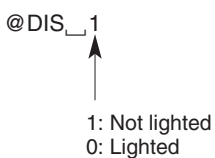

@AS

Function: Sets ON/OFF for autoscan function.
 Send example: @AS_1 c/r/f
 Response example: OK c/r/f
 Response example: NG c/r/f
 21: illegal type

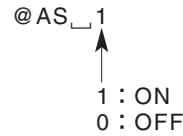

@PHL

Function: Sets ON/OFF for peak hold function.
 Send example: @PHL_1 c/r/f
 Response example: OK c/r/f
 Response example: NG c/r/f
 21: illegal type

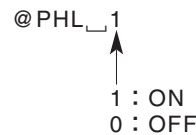

@BHL

Function: Sets ON/OFF for bottom hold function.
 Send example: @BHL_1 c/r/f
 Response example: OK c/r/f
 Response example: NG c/r/f
 21: illegal type

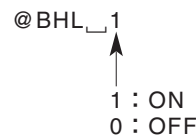

●Communication time chart

For sending @A

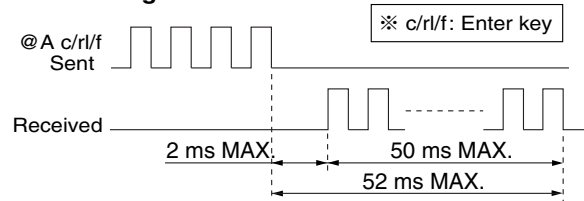

For sending @P, @PRE, @MODE

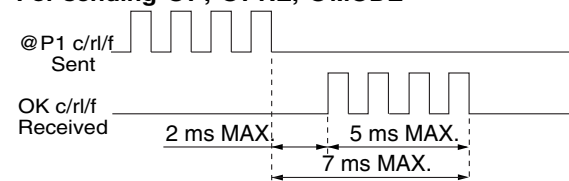

Communication

●Hyperterminal setting method

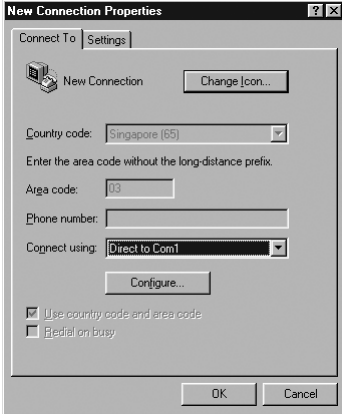

Figure 1

Click **File**, and then click **Property** to open the window at left, and set **Connect To**.

Click on **Configure...**

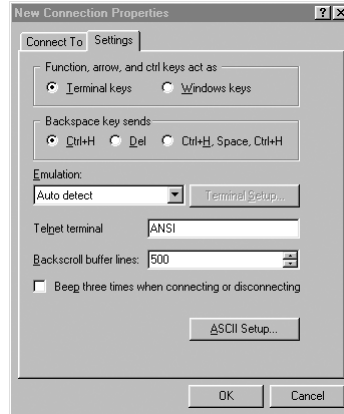

Figure 3

Clicking on the tag of the **Settings** in Figure 1 displays Figure 3. Click the **ASCII Setup...** button.

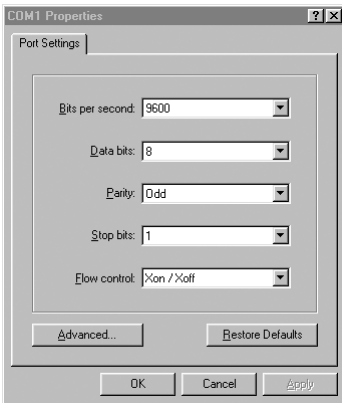

Figure 2

As shown in Figure 2, set the baud rate, etc.

Bits per second : 9600
 Data bits : 8
 Parity : Odd
 Stop bits : 1
 Flow control : Xon/Xoff

When the setting are complete, click **OK**.

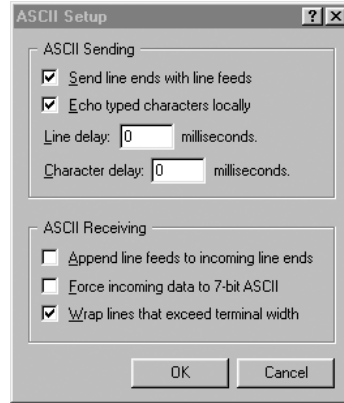
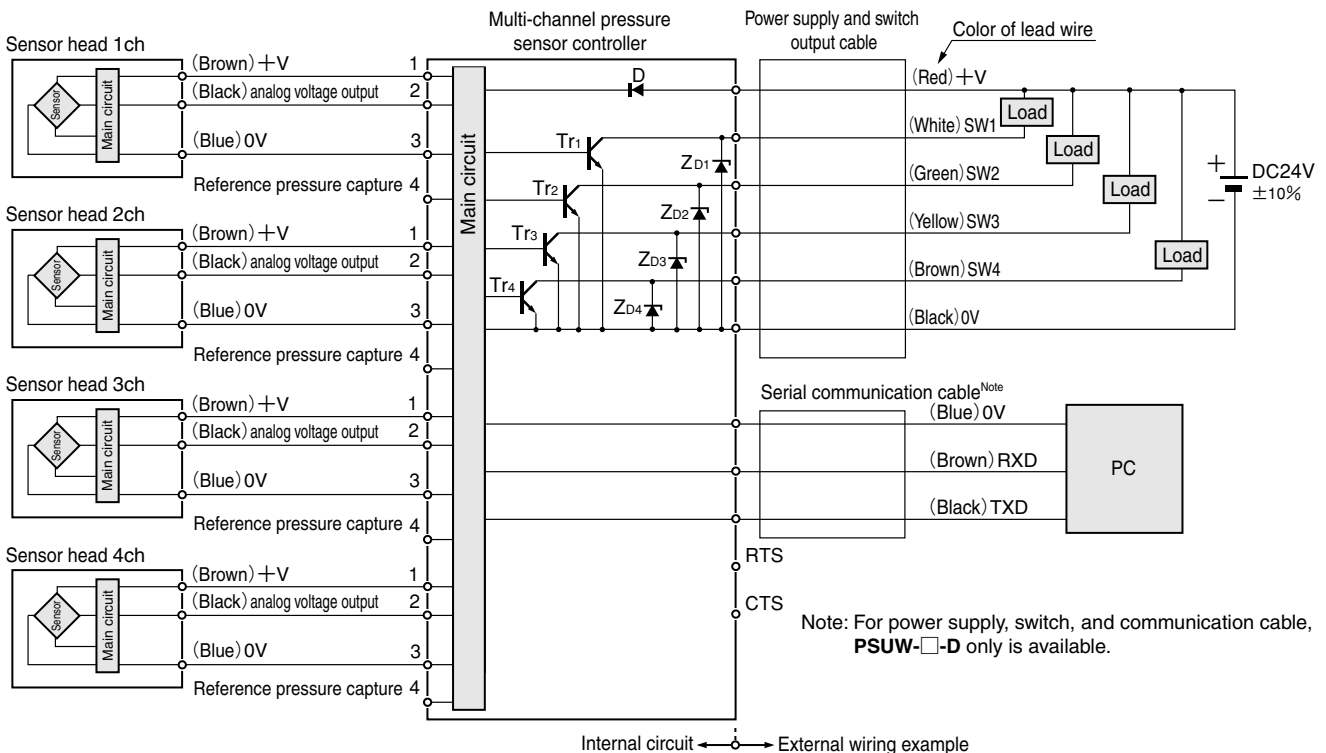

Figure 4

Set as shown in Figure 4, and click **OK**.

Return to Figure 3. Click **OK** again.

Internal Circuit Diagram and Wiring Specifications (External Wiring Example)



Note: Be aware that voltage drops as cable resistance increases when extending the cable.

Code D : Diode for reverse connecting protection of power supply
 ZD1~ZD4 : Zener diode for surge voltage absorption
 Tr1~Tr4 : NPN output transistor

MULTI-CHANNEL PRESSURE SENSOR CONTROLLERS

PSU



Specifications

● Multi-channel pressure sensor controller

Model		PSU
Power supply	Voltage	DC24V±10%
	Sensor head supply voltage	DC24V±10% ^{Note 1}
	Consumption current	100 mA MAX. (Not including current supplied to sensors)
Sensor input	Number of connected sensors	4
	Input voltage range	DC1.0~5.0V
	Maximum applied voltage	5.3V MAX.
SW output	Number of outputs	4
	Output method	NPN open collector
	Response time	3 ms
	Load voltage	DC30V MAX.
	Load current	50 mA MAX.
	Internal voltage drop	0.3V MAX./ at 5 mA
	Output mode	Hysteresis mode 1, Hysteresis mode 2 Hysteresis mode 3
Display	Pressure value display	7-segment LED, unit : kPa, 4-digit display
	Switch output confirmation display (SW.OUT)	When output Tr ON, lights up
	Autoscan channel confirmation display (A.S.OUT)	LED for the channel displaying pressure lights up
Pressure setting method	Body key setting	Key input \triangle : UP, ∇ : DOWN \square : MODE
	External setting (optional) ^{Note 2}	Serial (RS232C)
General	Operating temperature range	-10~50°C [14~122°F] Storage: -20~80°C [-4~176°F] (no condensation and freezing)
	Operating humidity range	35~80%RH
	Noise resistance	IEC61000-4-4 Power supply line 1 KV (level 2) Sensor input signal line 2 KV (level 3)
	Dielectric strength	AC500V 1 minute
	Insulation resistance	100 MΩ or more. (at DC500V megger)
	Vibration resistance	10~55 Hz (total amplitude 1.5 mm [0.059 in.]) XYZ-direction each 2 hours
	Shock resistance	490 m/s ² [50 G] Non-repeated shock
	Material	Case : PBT
	Mass	45 g [1.59 oz.]

- Notes: 1. The supply voltage to the sensor head is lower by 0.5V MAX than the controller power supply voltage.
2. **PSU-D**-□-□ only.

● Sensor head

Model		PSU-EA-□	PSU-ER-□	PSU-EM-□	
Media		Air or non-corrosive gas			
Power supply	Voltage	DC24V±10%			
	Consumption current	6 mA or less			
Analog Output	Output voltage	1~5V			
	Zero-point voltage (Vzero)	1±0.05V	3.75±0.05V	4.64±0.05V	
	Span voltage	4.00±0.07V (reference value)			
	Temperature characteristics	Vzero	Within ±30mV (at 0~50°C [32~122°F])		
		VSPAN	Within ±2% F.S. (at 0~50°C [32~122°F])		
Output current	1mA max. (load resistance 5 kΩ or more)				
General	Operating pressure range	0~-101.3 kPa [0~-14.7 psi.]	-100~220 kPa [-14.5~31.9 psi.]	-100~1000 kPa [-14.5~145 psi.]	
	Proof pressure	+900 kPa [131 psi.]		+1500 kPa [218 psi.]	
	Operating temperature range	0~50°C [32~122°F], Storage: -20~80°C [-4~176°F] (Storage: humidity 65%RH max. at atmospheric pressure)			
	Operating humidity range	35~85%RH			
	Insulation resistance	100 MΩ MIN (at DC500V megger)			
	Dielectric strength	AC500V 1 minute			
	Cable	Oil-resistant, bending-resistant PCCV 0.15SQX3-lead 3000 mm [118 in.]			
Mass	34 g [1.20 oz.] (with cable)				

Wiring specifications

Connector type	Item	Specification	
Made by JST B11B-XASK-1	Power supply	1 pin : 24V (red)	
		2 pin : 0V (black)	
	Data input and output	Switch output	3 pin : SW1 (white)
			4 pin : SW2 (green)
			5 pin : SW3 (yellow)
		RS232C ^{Note}	6 pin : SW4 (brown)
			7 pin : 0V (blue)
			8 pin : RXD (brown)
			9 pin : TXD (black)
			10 pin : N.C
			11 pin : N.C
Made by SUMITOMO 3M 37104-3101	Data input	1 pin : +V (brown)	
		2 pin : Sensor output (black)	
		3 pin : 0V (blue)	
		4 pin : PIN	

Note: **PSU-D**-□-□ only.

Order Codes

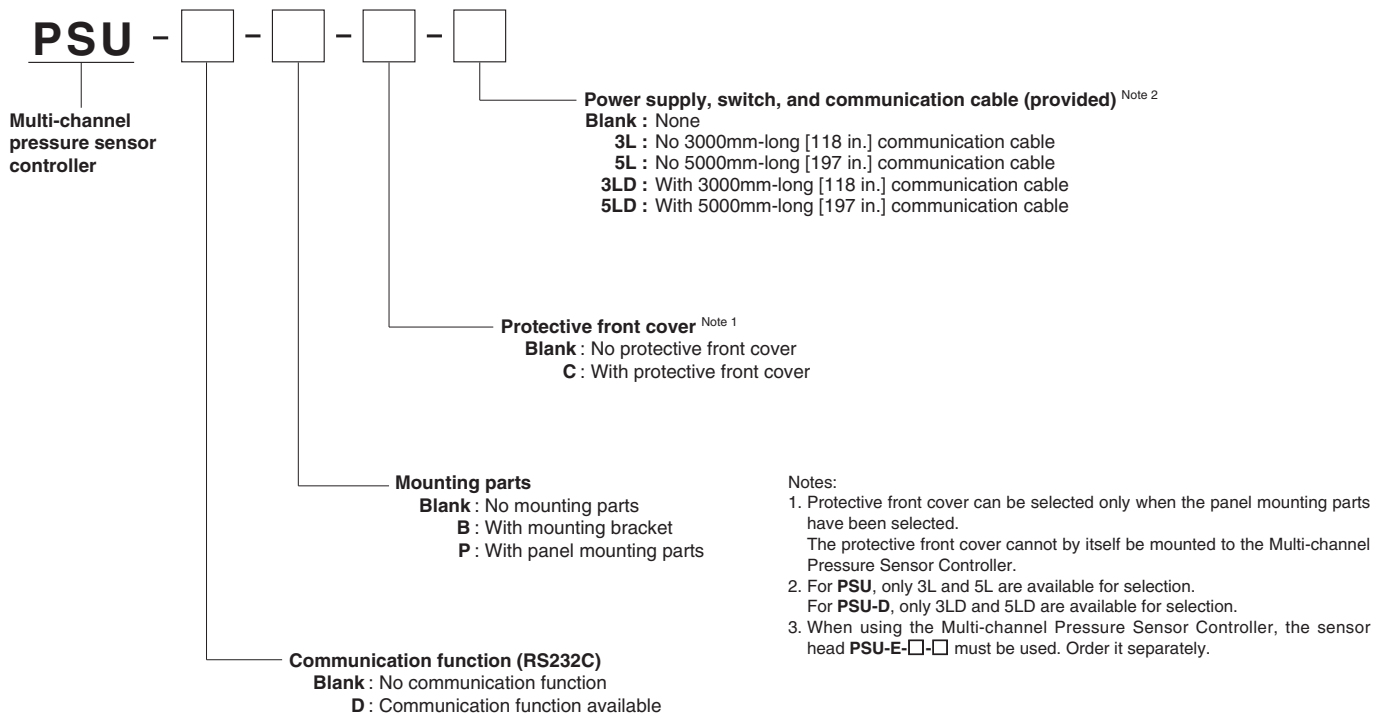

Additional parts (to be ordered separately)

Sensor head ^{Note 1}

● **PSU** - [] - []

Cable direction
L : Vertical wiring
S : Horizontal wiring

Pressure range
EA : For negative pressure (0~-101.3 kPa [0~-14.7 psi.])
ER : Coupled pressure (for low pressure) (-100 to 220 kPa [-14.5~31.9 psi.])
EM : Coupled pressure (for high pressure) (-100 to 1000 kPa [-14.5~145 psi.])

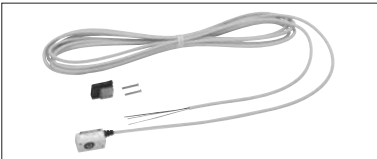

Sensor head connecting cable ^{Note 1}

● **PSUK** - []

Cable length
3L : 3000mm [118in.]
5L : 5000mm [197in.]



Power supply, switch, and communication cable

● **PSUW** - [] - []

Cable length
3L : 3000mm [118in.]
5L : 5000mm [197in.]

Communication cable
Blank : No communication cable ^{Note 2}
D : With communication cable ^{Note 3}



Mounting bracket

● **PSU-BR**



Panel mounting parts

● **PM100**



Protective front cover

● **KB100**

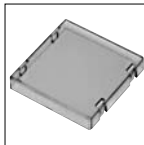

Mini clamp wire mounting plug

● **PSU-M**

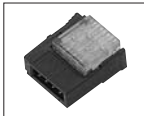

Notes: 1. The sensor head **PSU-EA-□** and sensor head connecting cable **PSUK-□** are delivered with the connectors un-connected.
 For the connection procedure, see p.784.
 2. Used with **PSU** only.
 3. Used with **PSU-D** only.

Dimensions (mm)

● PSU-□

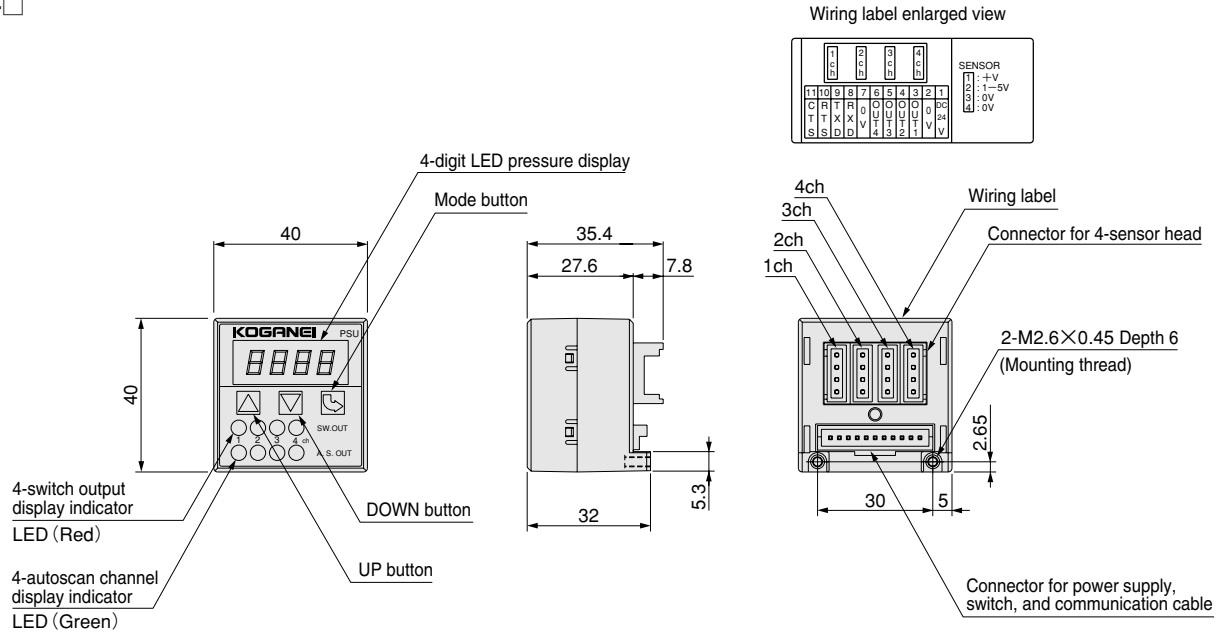

● PSU-EA-L^{Note} PSU-ER-L PSU-EM-L

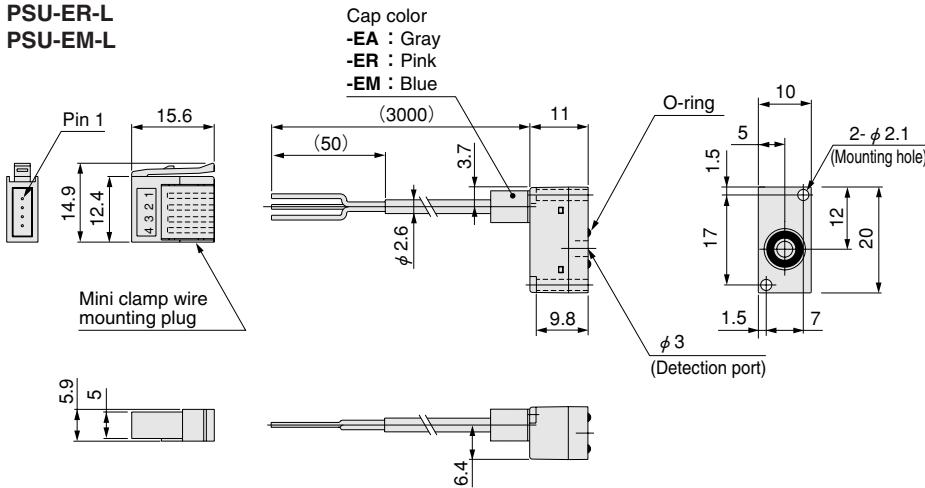

● Sensor head mounting dimensions (For 2 pcs. mounting) Surface roughness ∇ Ry6.3

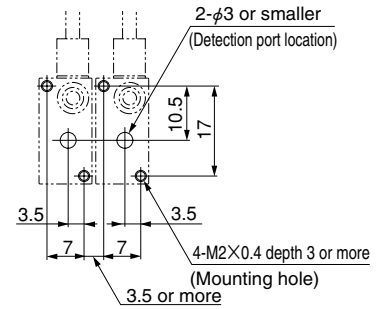

Note: The sensor head **PSU-□-□** comes with 2 mounting screws (M2×0.4, length 13).

● PSU-EA-S^{Note} PSU-ER-S PSU-EM-S

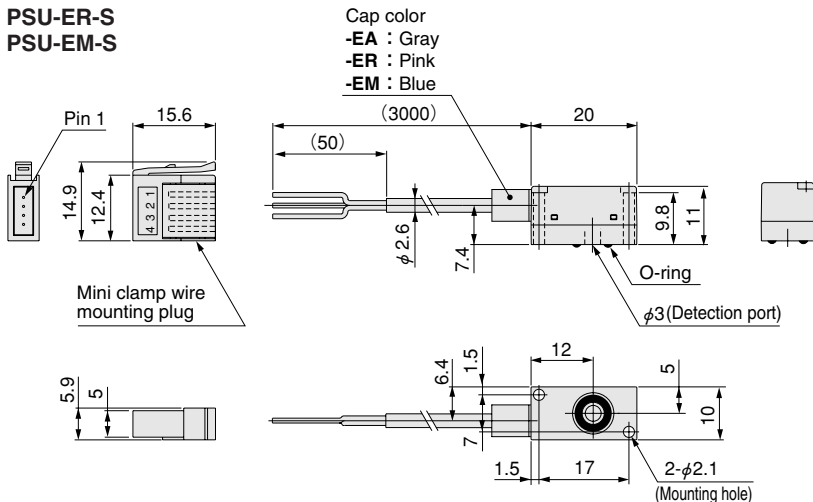

Note: The sensor head **PSU-□-□** comes with 2 mounting screws (M2×0.4, length 13).

Dimensions (mm)

●PSUK-□

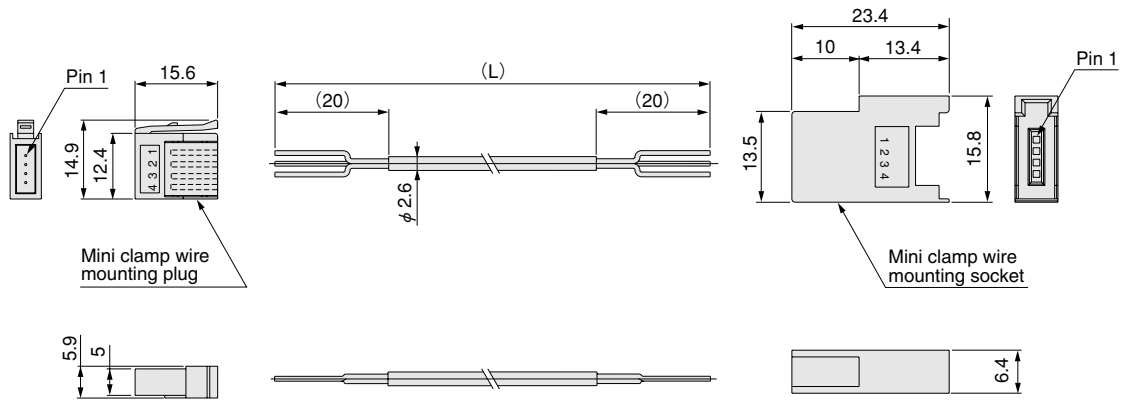

●PSUW-□-□

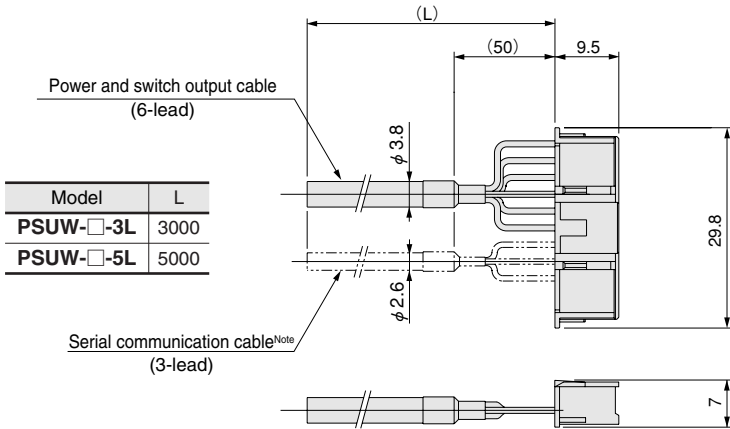

Note: Available for PSUW-D-□ only.

●PSU-BR

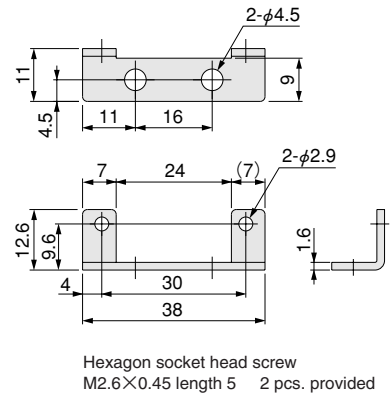

Dimensions (mm)

● PSU-□-P (Drawings for panel mounting)

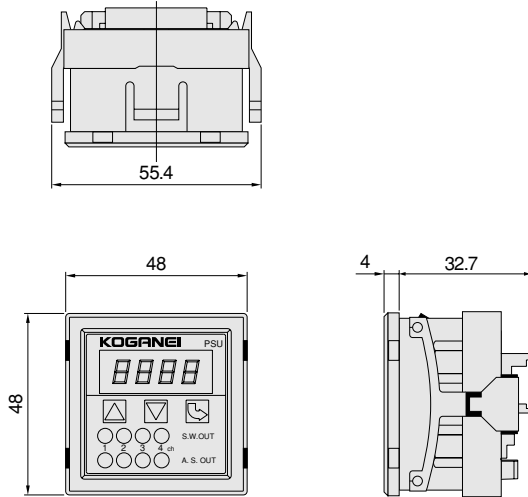

● Dimensions of cut panel for sensor controller mounting

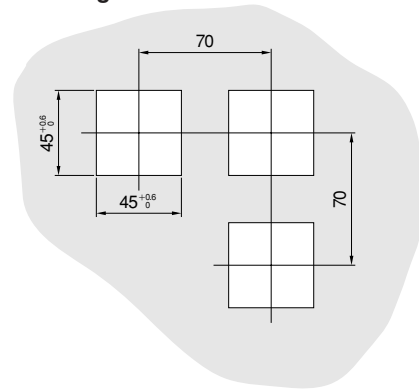

- Notes: 1. The mounting plate thickness should be 1~3.2 mm [0.039~0.126 in].
 2. If mounting in a series, space the units at intervals of the value shown in the figure above or greater.
 3. Conforms to **DIN43700** standard.

● KB100

