



CAD drawing data catalog is available.



# KOGANEI

## ACCESSORIES GENERAL CATALOG

AIR TREATMENT, AUXILIARY, VACUUM,  
AND FLUORORESIN PRODUCTS

## SPEED CONTROLLERS WITH QUICK FITTINGS CONTENTS

SPEED CONTROLLERS WITH QUICK FITTINGS

Low Speed Control Type	
Specifications (Low Speed Control Type)	393
Order Codes (Low Speed Control Type)	394
Dimensions (Low Speed Control Type)	395
Flow Rate Characteristics (Low Speed Control Type)	396
Free Type	
Specifications (Free Type)	397
Order Codes (Free Type)	398
Dimensions (Free Type)	399
Flow Rate Characteristics (Free Type)	400
Standard Type	
Mini Type	
Union Straight Type	
Large Flow Type	
Low Pressure Type	
Specifications (Standard Type, Mini Type, Union Straight Type, Large Flow Type, Low Pressure Type)	404
Order Codes, Size Table (Standard Type)	405
Order Codes, Size Table (Mini Type, Union Straight Type)	406
Order Codes, Size Table (Large Flow Type, Low Pressure Type)	407
Dimensions (Standard Type)	408
Dimensions (Mini Type)	410
Dimensions (Union Straight Type, Large Flow Type)	411
Dimensions (Low Pressure Type)	412
Flow Rate Characteristics (Standard Type)	414
Flow Rate Characteristics (Mini Type)	417
Flow Rate Characteristics (Union Straight Type)	419
Flow Rate Characteristics (Large Flow Type)	420
Flow Rate Characteristics (Low Pressure Type)	421
NCU Specification Order Codes, Model Table	423
Safety Precautions, Handling Instructions and Precautions	425



**Caution** Before use, be sure to read the "Safety Precautions" on p. 49.

# SPEED CONTROLLERS WITH QUICK FITTINGS

## Low Speed Control Type

- Speed controllers with quick fittings now available in new size of  $\phi$  1.8mm [0.071in.].
- More variation, with seven models available for  $\phi$  1.8mm [0.071 in.],  $\phi$  3mm [0.118in.], and  $\phi$  4mm [0.157in.] tubes.
- Offers best match for compact cylinders (Mini Guide Cylinders, Mini Bit Cylinders, etc.).

## Symbol

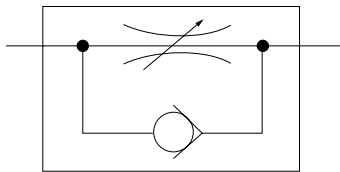

## Specifications

Item	Applicable tube size mm [in.]	$\phi$ 1.8 [0.071]	$\phi$ 3 [0.118]	$\phi$ 4 [0.157]
Media		Air (Can not be used in vacuum system)		
Operating pressure range		0 ~ 0.9MPa [0 ~ 131psi.]		
Cracking pressure		0.05MPa [7.3psi.]		
Operating temperature range		0 ~ 60°C [32 ~ 140°F]		
Recommended tube <sup>Note</sup>		Urethane tube		Urethane tube, soft nylon tube, nylon tube
Sales unit		1 pc.		

Remark: Supplied with a gasket (excluding **SSUC**□).

Note: Use tubes manufactured by Koganei. Be aware, however, that the conductive urethane tube **U2A-B** cannot be used.

## Inner Construction and Major Parts

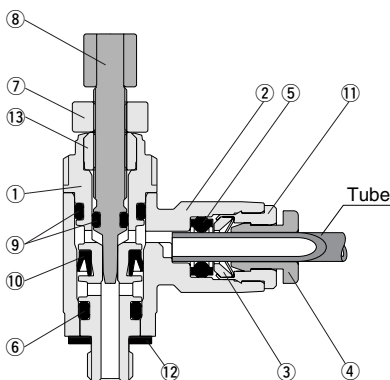

No.	Name	Material
①	Metal body	Stainless steel <sup>Note</sup>
②	Plastic body	Polybutylene terephthalate
③	Lock claw	Stainless steel
④	Release ring	Polyacetal
⑤	Elastic sleeve	Synthetic rubber (NBR)
⑥	O-ring	Synthetic rubber (NBR)
⑦	Lock nut	Stainless steel
⑧	Needle	Stainless steel
⑨	O-ring	Synthetic rubber (NBR)
⑩	Diaphragm	Synthetic rubber (H-NBR)
⑪	Guide ring	Brass (electroless nickel plated)
⑫	Gasket	Stainless steel and synthetic rubber (NBR)
⑬	Upper plug	Stainless steel

Note: The connecting screw **M5** and the union type **SSUC** are made of brass (electroless nickel plated).

## Order Codes

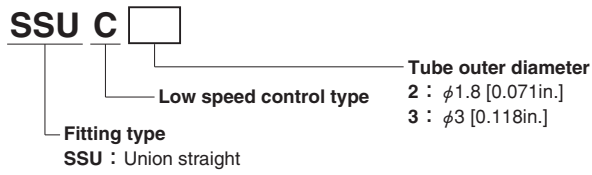
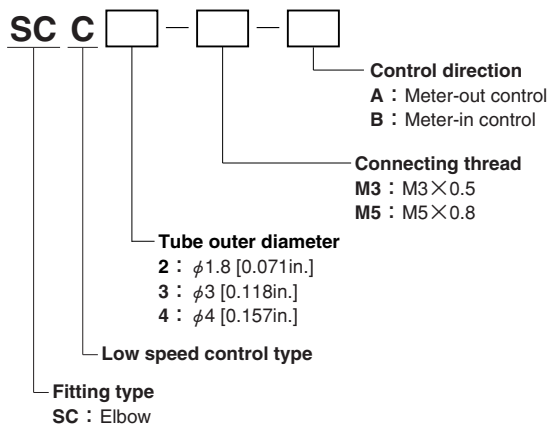

## Body Configuration and Control Direction

### ● Elbow type SCC

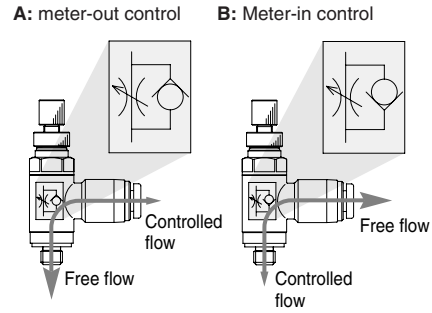

### ● Union Type SSUC

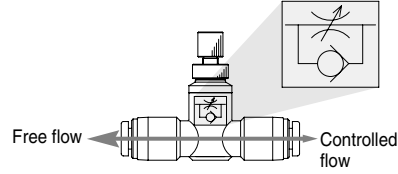

Remark: For the control direction, check the symbol on the main body.

### ● SCC Elbow



Tube size	Thread size	
	M3×0.5	M5×0.8
2	M3	M5
3	M3	M5
4	M3	— <sup>Note</sup>

### ● SSUC Union straight



Tube size
2
3

Note: For tube sizes φ 4 [0.157in.] to φ 10 [0.394in.], see p.1540~1542 in the Actuators General Catalog.

# Dimensions mm [in.]

## ● Elbow SCC

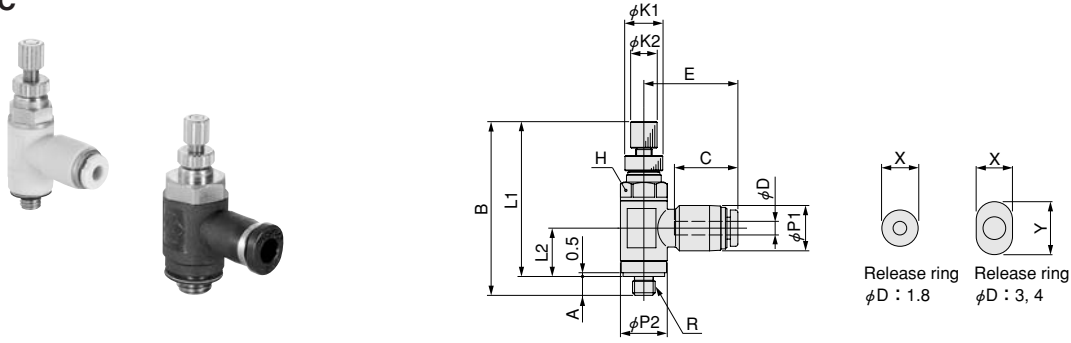

Model	Tube diameter φ D	R	A	B		L1		L2	E	C	φ P1	φ P2	φ K1	φ K2	Width across flats H	X	Y	Mass (g) [oz.]
				MAX.	MIN.	MAX.	MIN.											
SCC2-M3-□	1.8 [0.071]	M3×0.5	2.5 [0.098]	25.7 [1.012]	23 [0.906]	23.2 [0.913]	20.5 [0.807]	6.4 [0.252]	12.5 [0.492]	8.4 [0.331]	6 [0.236]	6.2 [0.244]	5 [0.197]	3.5 [0.138]	5.5 [0.217]	4.8 [0.189]	—	2.7 [0.095]
SCC2-M5-□		M5×0.8	3 [0.118]	27.2 [1.071]	24.5 [0.965]	24.2 [0.953]	21.5 [0.846]	7.2 [0.283]	13.5 [0.531]									
SCC3-M3-□	3 [0.118]	M3×0.5	2.5 [0.098]	25.7 [1.012]	23 [0.906]	23.2 [0.913]	20.5 [0.807]	6.4 [0.252]	13 [0.512]	9.3 [0.366]	6 [0.236]	6.2 [0.244]	5 [0.197]	3.5 [0.138]	5.5 [0.217]	6 [0.236]	7 [0.276]	2.7 [0.095]
SCC3-M5-□		M5×0.8	3 [0.118]	27.2 [1.071]	24.5 [0.965]	24.2 [0.953]	21.5 [0.846]	7.2 [0.283]	14 [0.551]									
SCC4-M3-□	4 [0.157]	M3×0.5	2.5 [0.098]	25.7 [1.012]	23 [0.906]	23.2 [0.913]	20.5 [0.807]	6 [0.236]	14.7 [0.579]	11 [0.433]	8 [0.315]	6.2 [0.244]	5 [0.197]	3.5 [0.138]	5.5 [0.217]	7.8 [0.307]	9.8 [0.386]	3.1 [0.109]

Note: In the blank box □ shown at the end of the model code, enter **A** for meter-out control or **B** for meter-in control.

## ● Union SSUC

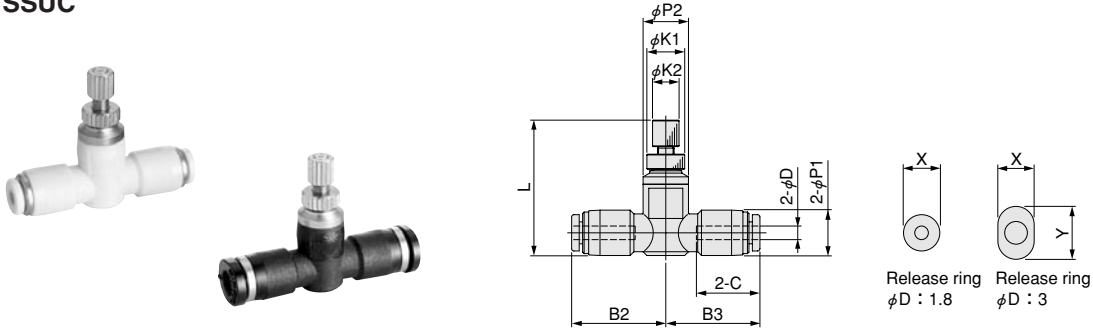

Model	Tube diameter φ D	L		B2	B3	C	φ P1	φ P2	φ K1	φ K2	X	Y	Mass (g) [oz.]
		MAX.	MIN.										
SSUC2	1.8 [0.071]	20.6 [0.811]	17.9 [0.705]	12.5 [0.492]	12.5 [0.492]	8.4 [0.331]	6 [0.236]	6 [0.236]	5 [0.197]	3.5 [0.138]	4.8 [0.189]	—	2.8 [0.099]
SSUC3	3 [0.118]	20.6 [0.811]	17.9 [0.705]	13 [0.512]	13 [0.512]	9.3 [0.366]							

# Flow Rate Characteristics

## SCC2-M3-□

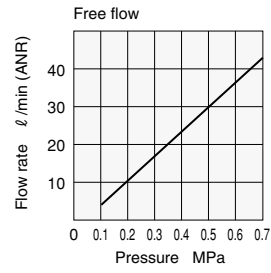
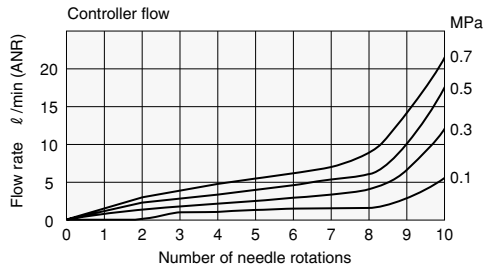

1 MPa = 145psi.  
1  $\ell$ /min = 0.0353ft.<sup>3</sup>/min.

## SCC2-M5-□

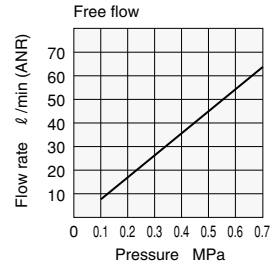
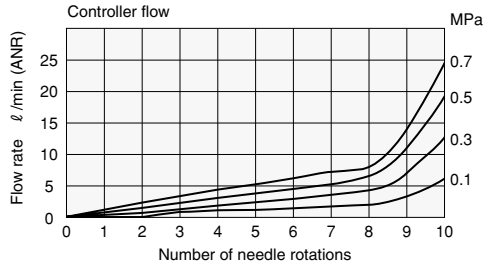

1 MPa = 145psi.  
1  $\ell$ /min = 0.0353ft.<sup>3</sup>/min.

## SCC3-M3-□

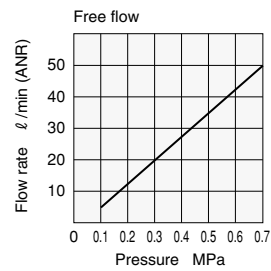
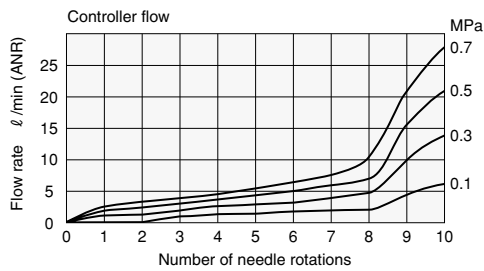

1 MPa = 145psi.  
1  $\ell$ /min = 0.0353ft.<sup>3</sup>/min.

## SCC3-M5-□

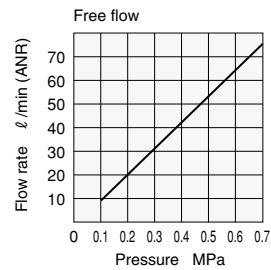
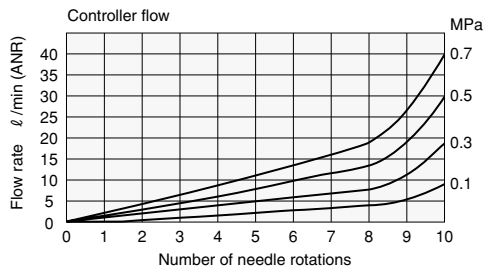

1 MPa = 145psi.  
1  $\ell$ /min = 0.0353ft.<sup>3</sup>/min.

## SCC4-M3-□

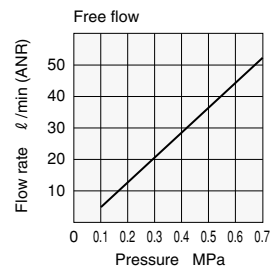
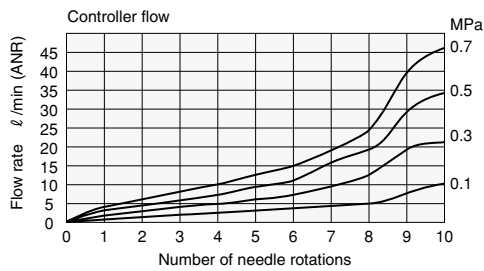

1 MPa = 145psi.  
1  $\ell$ /min = 0.0353ft.<sup>3</sup>/min.

## SSUC2

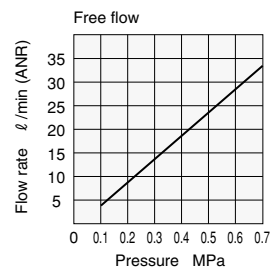
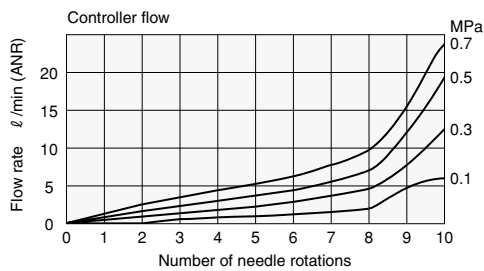

1 MPa = 145psi.  
1  $\ell$ /min = 0.0353ft.<sup>3</sup>/min.

## SSUC3

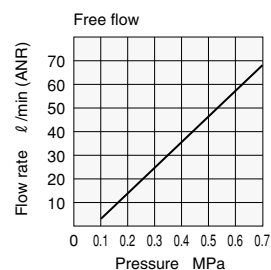
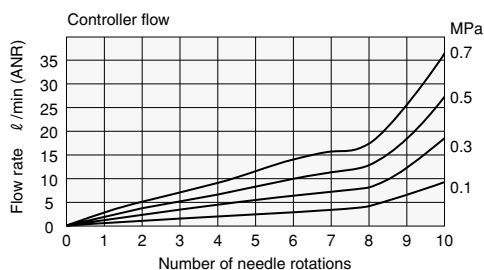

1 MPa = 145psi.  
1  $\ell$ /min = 0.0353ft.<sup>3</sup>/min.

# SPEED CONTROLLERS WITH QUICK FITTINGS

Free Type, Horizontal Free Type, Free Type for Low Pressure, Horizontal Free Type for Low Pressure

● Can be rotated on the A, B (or C) axes, enabling any piping direction.

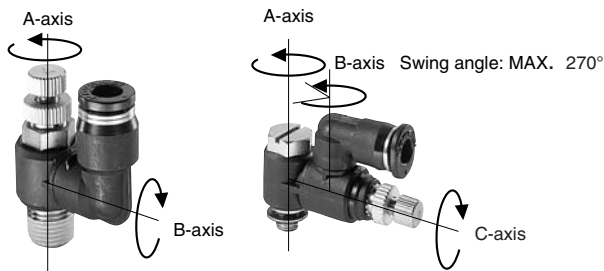

## Symbol

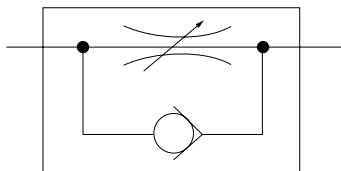

## Specifications

Item	Model	Free type	Free type for low pressure	Horizontal free type	Horizontal free type for low pressure
Media		Air (Cannot be used in vacuum systems)			
Operating pressure range		0~0.9MPa [0~131psi.]	0~0.5MPa [0~73psi.]	0~0.9MPa [0~131psi.]	0~0.5MPa [0~73psi.]
Cracking pressure		0.05MPa [7psi.]	0.02MPa [3psi.]	0.05MPa [7psi.]	0.02MPa [3psi.]
Operating temperature range		0~60°C [32~140°F]			
Recommended tube		Nylon tube, urethane tube			
Sales unit		1 pc.			

Remark: Supplied with a gasket or sealant coated.

## Inner Construction, Major Parts and Materials

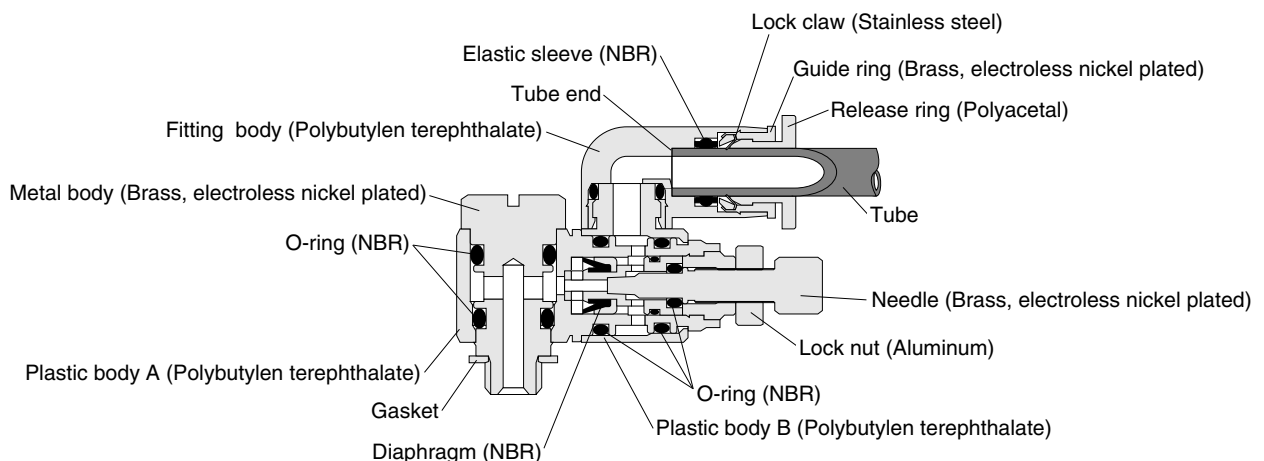

# Order Codes

## ● Free type    ● Free type for low pressure

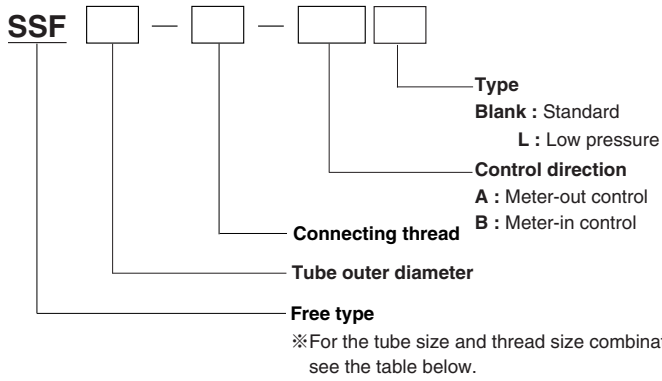

● For the NCU specification, see p.423.

### Body configuration and control direction

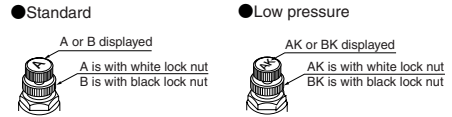
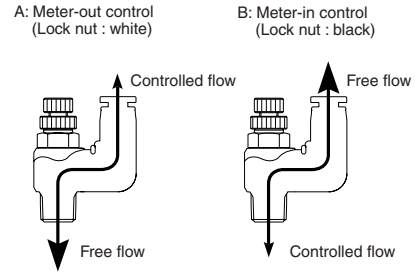

※Use the stamped mark on the needle head, and the color of the nut, to distinguish between meter-out and meter-in control.



## ● Free type

Tube size	Thread size				
	M5×0.8	R1/8	R1/4	R3/8	R1/2
4	M5	01	—	—	—
6	M5	01	02	—	—
8	—	01	02	03	—
10	—	—	02	03	—
12	—	—	—	03	04

## ● Free type for low pressure

Tube size	Thread size		
	M5×0.8	R1/8	R1/4
4	M5	01	—
6	M5	01	02
8	—	01	02
10	—	—	02

## ● Horizontal free type    ● Horizontal free type for low pressure

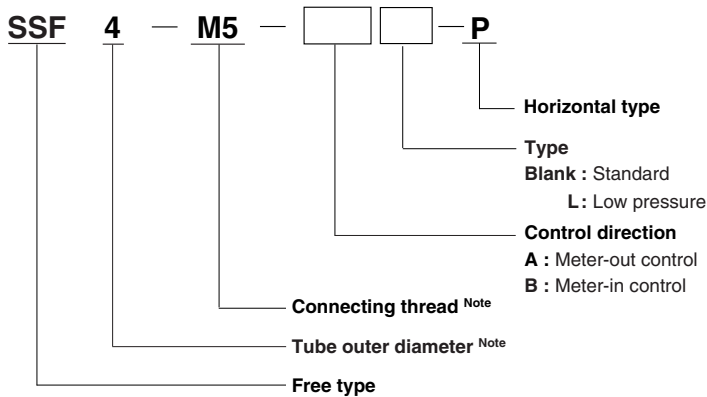

Note: The horizontal free type, and horizontal free type for low pressure are limited to tube outer diameter of  $\phi 4$ , and to connecting thread of M5×0.8 only.

● For the NCU specification, see p.423.



### Body configuration and control direction

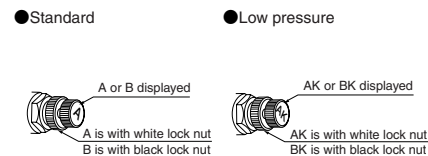
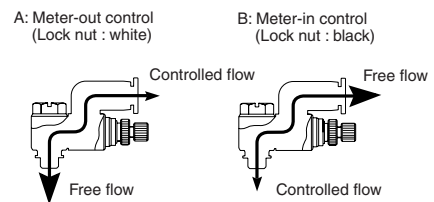

※Use the stamped mark on the needle head, and the color of the nut, to distinguish between meter-out and meter-in control.

## Dimensions (Free Type, Free Type for Low Pressure) (mm)

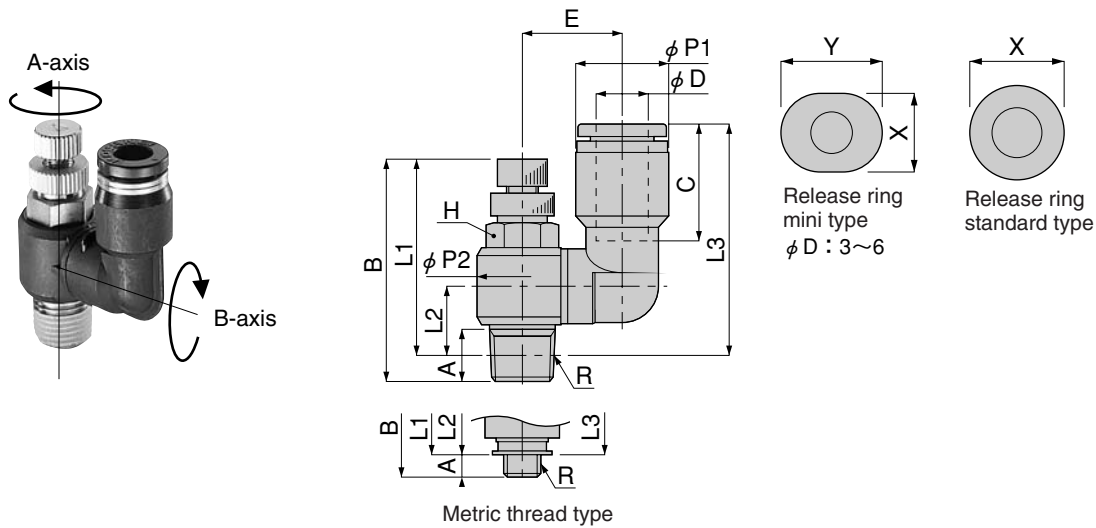

Model <sup>Note2</sup>	Tube outer diameter $\phi D$	R	A	B		L1 <sup>Note 1</sup>		L2 <sup>Note 1</sup>	L3 <sup>Note 1</sup>	$\phi P1$	$\phi P2$	C	E	Width across flats H	X	Y	Mass (g) [oz.]	
				MAX	MIN	MAX	MIN											
SSF4-M5-□(L)	4	M5×0.8	2.9	29.7	27	26.8	24.1	6.7	22.8	8	9.8	11	10	8	7.8	9.8	7.7 [0.272]	
SSF4-01-□(L)		R1/8	8	40.7	34.4	36.7	30.4	10.7	26.8		14.4		12.2				10	18 [0.63]
SSF6-M5-□(L)	6	M5×0.8	2.9	29.7	27	26.8	24.1	6.7	24.2	10.5	9.8	11.6	10.5	8	9.8	11.8	8.4 [0.296]	
SSF6-01-□(L)		R1/8	8	40.7	34.4	36.7	30.4	10.7	28.2		14.4		12.7				10	18 [0.63]
SSF6-02-□(L)		R1/4	11.1	47.8	41.4	41.8	35.4	11.9	29.4		18.4		14.7				14	35 [1.23]
SSF8-01-□(L)	8	R1/8	8	40.7	34.4	36.7	30.4	10.7	36.4	14.5	14.4	18.1	15.5	10	13.8	—	22 [0.78]	
SSF8-02-□(L)		R1/4	11.1	47.8	41.4	41.8	35.4	11.9	37.6		18.4		17.5				14	39 [1.38]
SSF8-03-□		R3/8	13.2	53.7	46.5	47.3	40.1	15.6	43.3		22		20				19	68 [2.40]
SSF10-02-□(L)	10	R1/4	11.1	47.8	41.4	41.8	35.4	11.9	40.9	17.5	18.4	20.2	18	14	16.8	—	42 [1.48]	
SSF10-03-□		R3/8	13.2	53.7	46.5	47.3	40.1	15.6	45.6		22		20.5				19	71 [2.50]
SSF12-03-□	12	R3/8	13.2	53.7	46.5	47.3	40.1	15.6	49.3	21	22	23.4	21	19	19.8	—	74 [2.61]	
SSF12-04-□		R1/2	16	59.3	52.3	51.1	44.1	18	53.2		28		25				24	110 [3.88]

Notes : 1. The L1, L2 and L3 dimensions for the tapered thread type are the reference dimensions after the fittings are assembled.

2. In the blank box of the model order code, enter **A** for meter-out control or **B** for meter-in control. Also, the **(L)** listed to the right of the model order code refers to low pressure. For low pressure specification (cracking pressure of 0.02MPa [3psi.]), remove the parentheses and enter **L** into the order code. (Products without the **(L)** designation do not offer low pressure specification.)

## Dimensions (Horizontal Free Type, Horizontal Free Type for Low Pressure) (mm)

### SSF-4-M5-□□-P

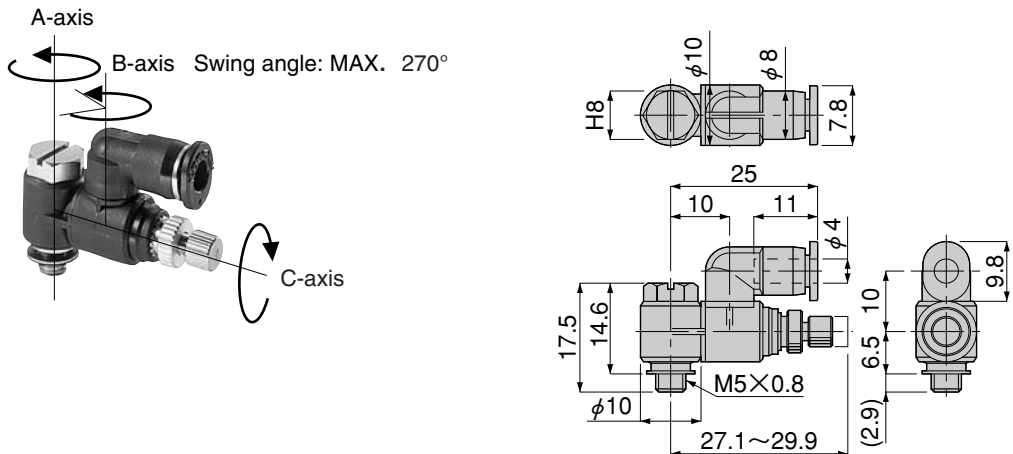

Mass : 9.5g [0.335oz.]



# Flow Rate Characteristics (Free Type)

SSF4-M5-□

SSF6-M5-□

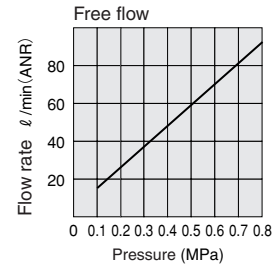
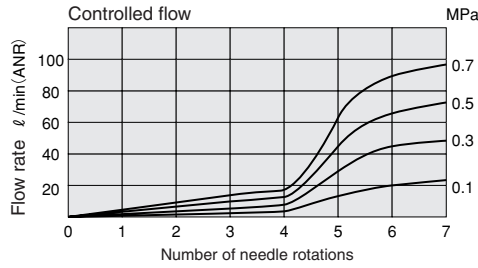

1MPa = 145psi. 1 l/min = 0.0353ft<sup>3</sup>/min.

SSF4-01-□

SSF6-01-□

SSF8-01-□

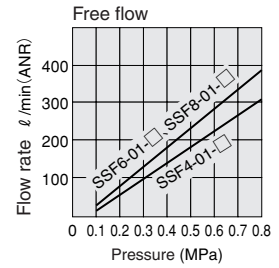
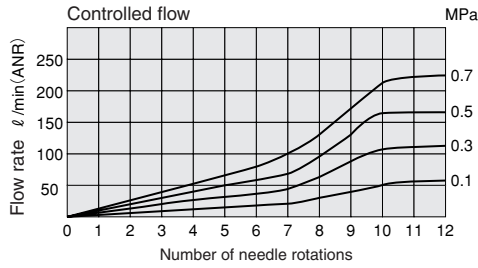

1MPa = 145psi. 1 l/min = 0.0353ft<sup>3</sup>/min.

SSF6-02-□

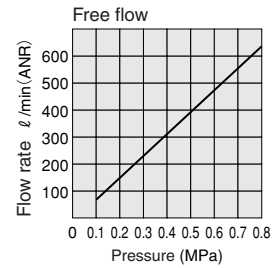
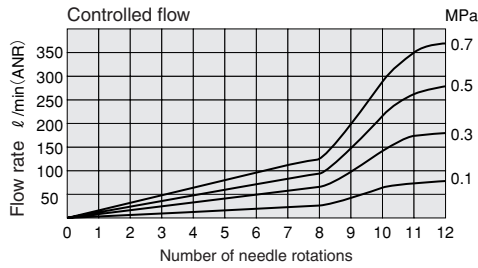

1MPa = 145psi. 1 l/min = 0.0353ft<sup>3</sup>/min.

SSF8-02-□

SSF10-02-□

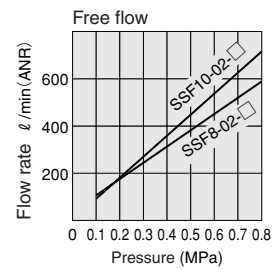
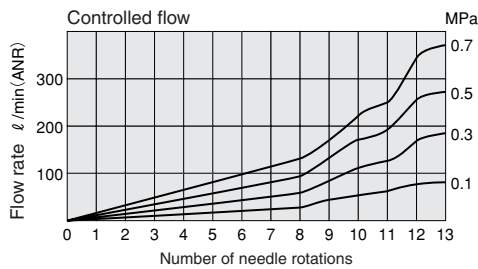

1MPa = 145psi. 1 l/min = 0.0353ft<sup>3</sup>/min.

SSF8-03-□

SSF10-03-□

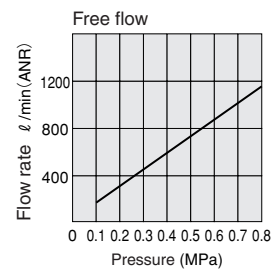
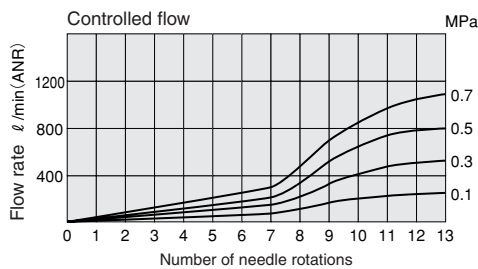

1MPa = 145psi. 1 l/min = 0.0353ft<sup>3</sup>/min.

## Flow Rate Characteristics (Free Type)

SSF12-03-□

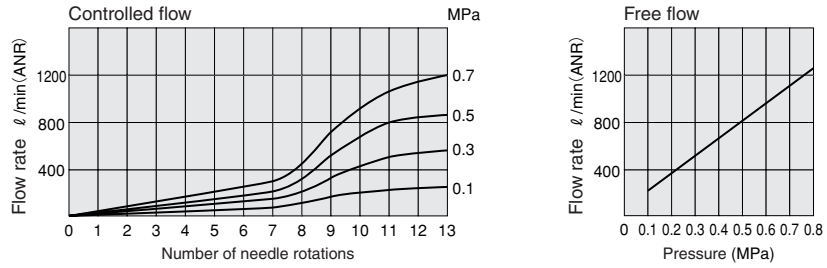

1MPa = 145psi. 1 l/min = 0.0353ft<sup>3</sup>/min.

SSF12-04-□

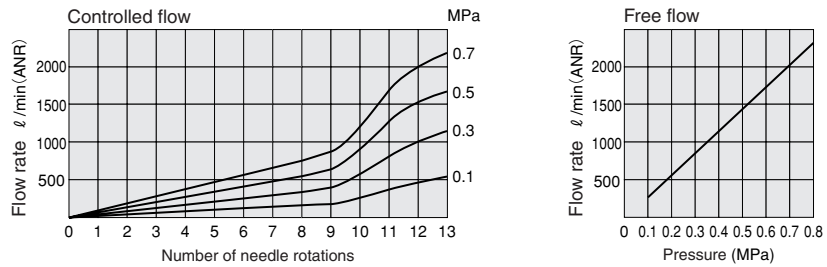

1MPa = 145psi. 1 l/min = 0.0353ft<sup>3</sup>/min.

## Flow Rate Characteristics (Horizontal Free Type)

SSF4-M5-□-P

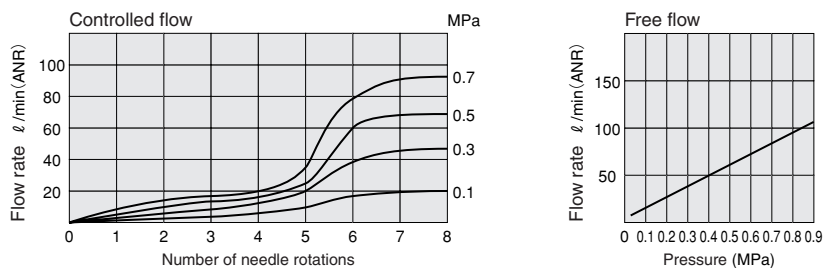

1MPa = 145psi. 1 l/min = 0.0353ft<sup>3</sup>/min.

# Flow Rate Characteristics (Free Type for Low Pressure, Horizontal Free Type for Low Pressure)

## SSF4-M5-□L-P

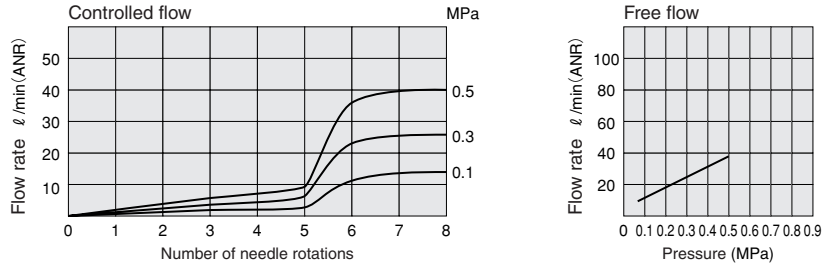

1MPa = 145psi. 1 l/min = 0.0353ft<sup>3</sup>/min.

## SSF4-M5-□L SSF6-M5-□L

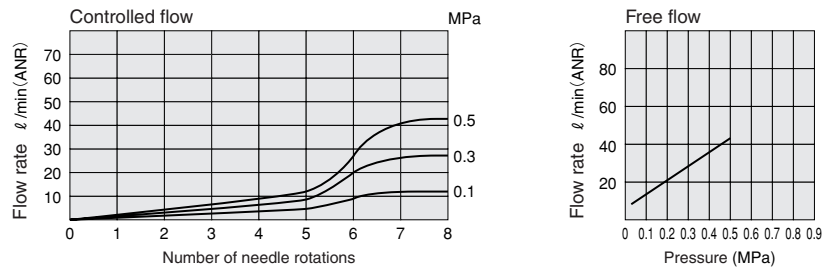

1MPa = 145psi. 1 l/min = 0.0353ft<sup>3</sup>/min.

## SSF4-01-□L SSF6-01-□L SSF8-01-□L

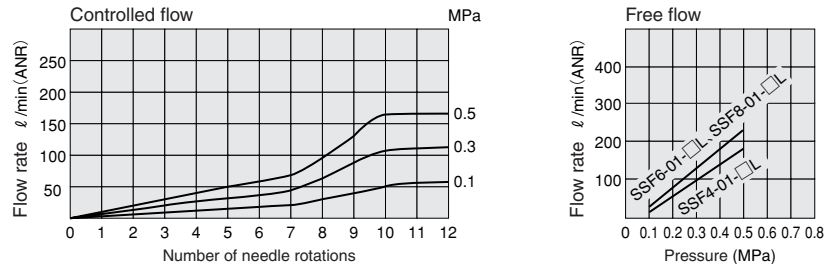

1MPa = 145psi. 1 l/min = 0.0353ft<sup>3</sup>/min.

## SSF6-02-□L

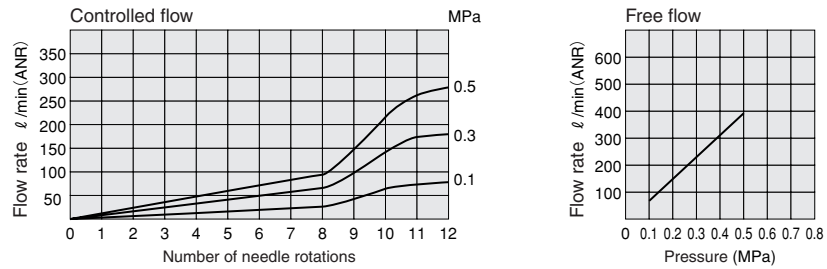

1MPa = 145psi. 1 l/min = 0.0353ft<sup>3</sup>/min.

# Flow Rate Characteristics (Horizontal Free Type for Low Pressure)

SSF8-02-□L  
 SSF10-02-□L

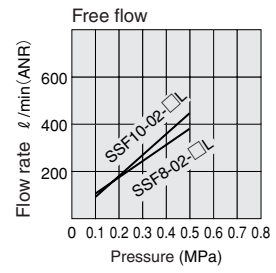
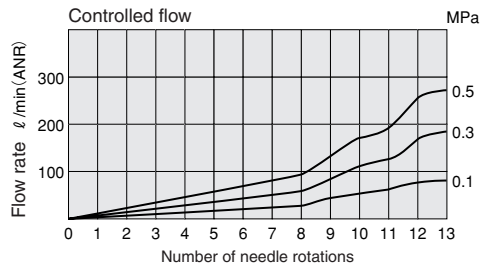

1MPa = 145psi. 1l/min = 0.0353ft<sup>3</sup>/min.

# SPEED CONTROLLERS WITH QUICK FITTINGS

## Standard Type, Mini Type, Union Straight Type, Large Flow Type, Low Pressure Type

- Offer speed control fittings for cylinders and other actuators.
- Superior flow rate characteristics assure fine-tuned adjustment in low-speed ranges.
- Available model types include the standard type, union straight type, low pressure type, large flow type, and mini type.

### Specifications

Type	Standard type	Mini type	Union straight type	Large flow type	Low pressure type
Mounting type	Direct cylinder mounting		-----	Direct cylinder mounting	
Media	Air (Cannot be used in vacuum systems)				
Operating pressure range	0~0.9MPa [0~131psi.]				0~0.5MPa [0~73psi.]
Cracking pressure	0.05MPa [7psi.]				0.02MPa [3psi.]
Operating temperature range	5~60°C [41~140°F]				
Recommended tube	Nylon tube, urethane tube				
Sales unit	1 pc.				

Remark: Supplied with a gasket or sealant coated.

### Symbol

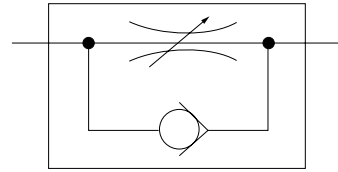

### Inner Construction, Major Parts and Materials

- Standard type
- Mini type
- Large flow type
- Low pressure type

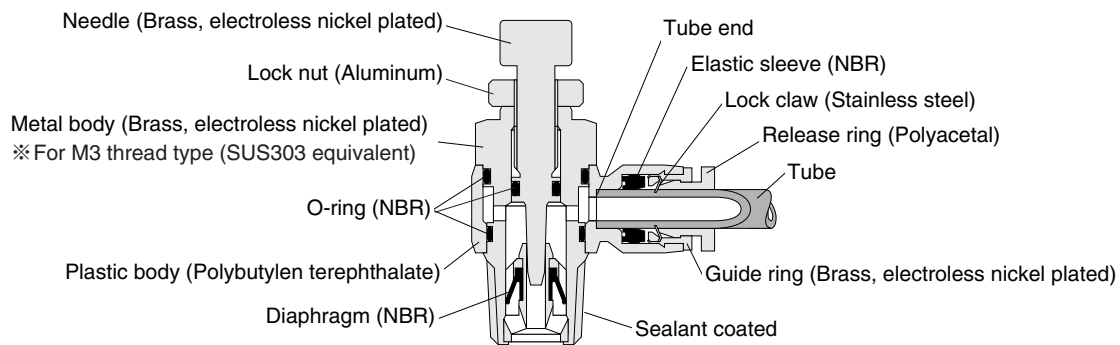

# Order Codes

## ● Standard type

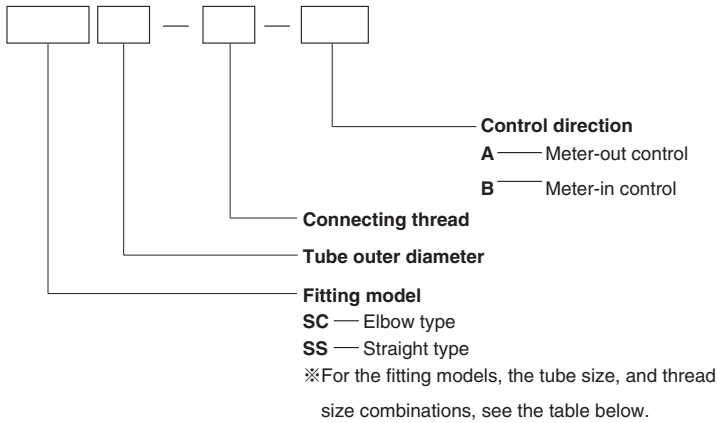

● For the NCU specification, see p.423.

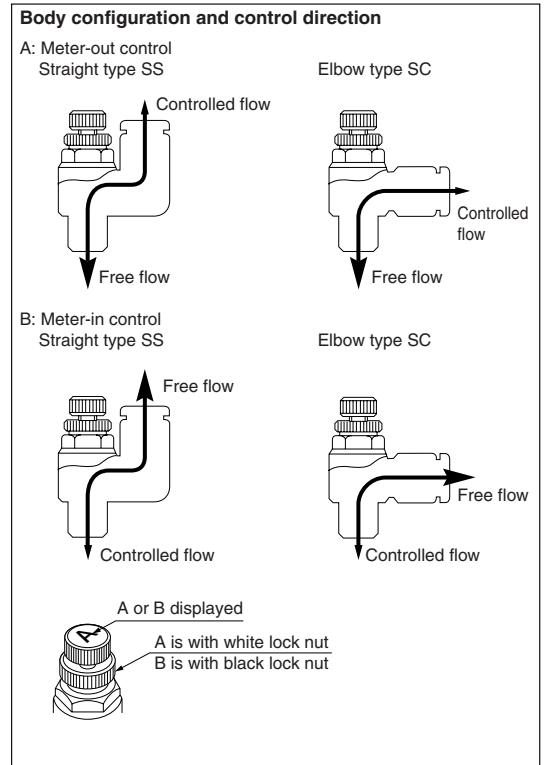

## ● SC Elbow 408



Tube size	Thread size				
	M5×0.8	R1/8	R1/4	R3/8	R1/2
4	M5	01	—	—	—
6	M5	01	02	03	—
8	—	01	02	03	04
10	—	—	02	03	04
12	—	—	—	03	04

## ● SS Straight 409



Tube size	Thread size				
	M5×0.8	R1/8	R1/4	R3/8	R1/2
4	M5	01	—	—	—
6	M5	01	02	—	—
8	—	01	02	03	—
10	—	—	02	03	—
12	—	—	—	03	04

# Order Codes

## ● Mini Type

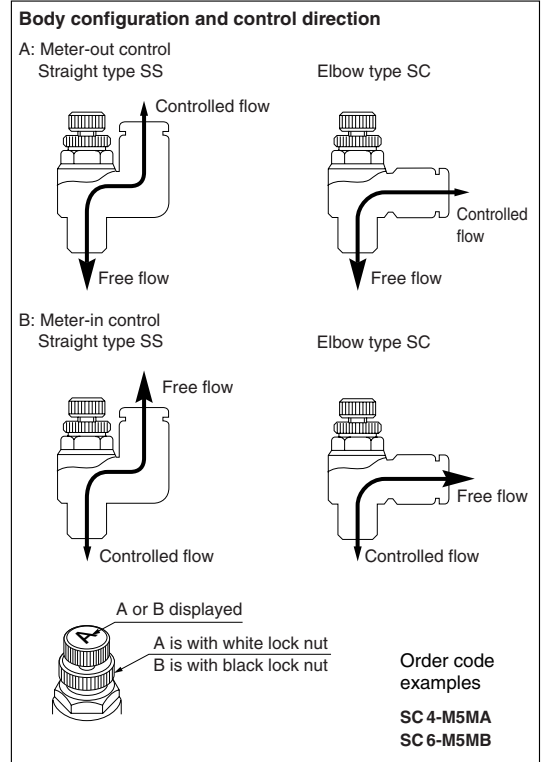
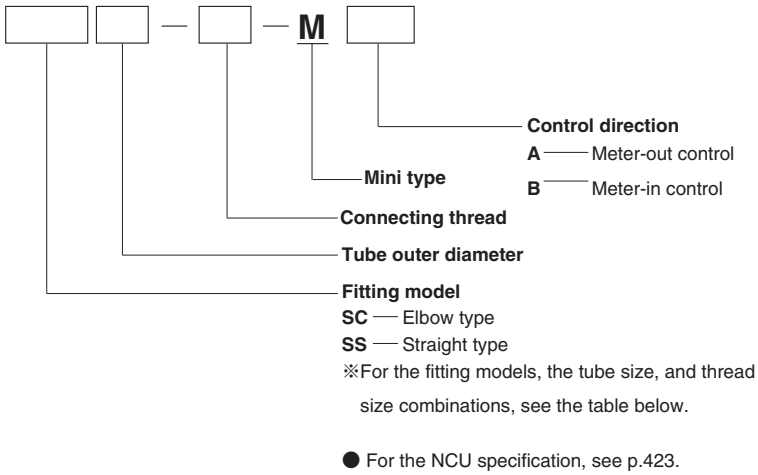

SPEED CONTROLLERS WITH QUICK FITTINGS

## ● SC Elbow 410



Tube size	Thread size			
	M3×0.5	M5×0.8	R1/8	R1/4
3	M3	M5	—	—
4	M3	M5	01	—
6	—	M5	01	02

## ● SS Straight 410



Tube size	Thread size			
	M3×0.5	M5×0.8	R1/8	R1/4
3	M3	M5	—	—
4	M3	M5	01	—
6	—	M5	01	—

## ● Union straight type

SSU [ ]



**Tube outer diameter**

4 —  $\phi$  4  
6 —  $\phi$  6  
8 —  $\phi$  8  
10 —  $\phi$  10  
12 —  $\phi$  12

**Union straight type**

● For the dimensions, see p.411.  
● For the NCU specification, see p.423.

**Caution:** For the union straight type, no order code is available for control direction.  
To determine the mounting direction, check the speed controller's symbol on the side of the body.

# Order Codes

## ● Large flow type

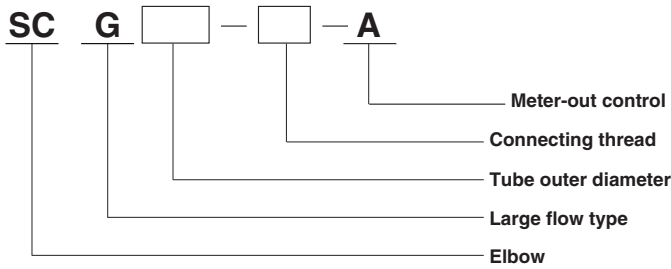

Tube size	Thread size			
	R1/8	R1/4	R3/8	R1/2
6	01	02	—	—
8	01	02	03	—
10	—	02	03	—
12	—	—	03	04

● For the dimensions, see p.411.

※For the fitting models, the tube size, and thread size combinations, see the table below.

● For the NCU specification, see p.423.

### Body configuration and control direction

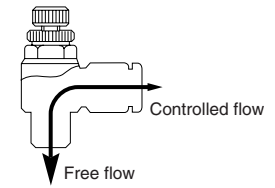

**Caution:** The large flow type can be identified by the AG mark on the needle head, and by a blue lock nut.

## ● Low pressure type

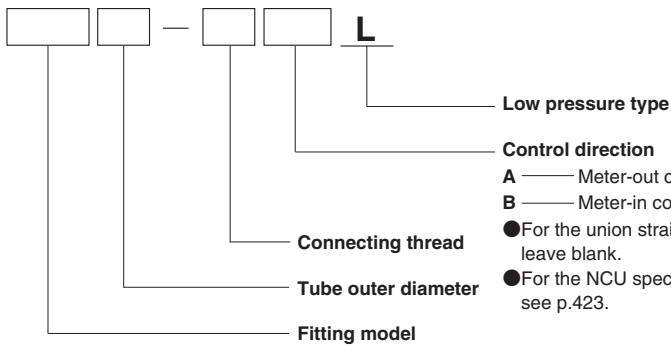

Low pressure type

Control direction

A — Meter-out control

B — Meter-in control

● For the union straight type, leave blank.

● For the NCU specification, see p.423.

Connecting thread

Tube outer diameter

Fitting model

※For the fitting models, the tube size, and thread size combinations, see the table below.

**Caution:** The low pressure type can be identified by the AK, BK, or K mark on the needle head.

AK : Elbow, low pressure, meter-out

BK : Elbow, low pressure, meter-in

K : Union straight, low pressure

### Body configuration and control direction

A: Meter-out control (lock nut: white)

Straight type SS

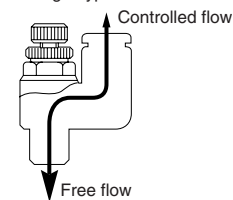

Elbow type SC

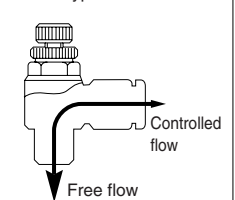

B: Meter-in control (lock nut: black)

Straight type SS

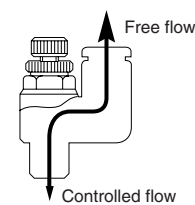

Elbow type SC

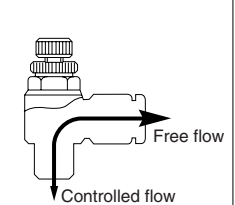

AK or BK displayed



AK is with white lock nut

BK is with black lock nut

※The meter-out or meter-in control can be identified by the AK or BK mark on the needle head and lock nut color.

● Union straight type

※For the union straight type, no order code is available for control direction. To determine the mounting direction, check the speed controller's symbol on the side of the plastic body.

## ● SS Straight 412



Tube size	Thread size		
	M5×0.8	R1/8	R1/4
4	M5	01	—
6	M5	01	02

## ● SC Elbow 412



Tube size	Thread size		
	M5×0.8	R1/8	R1/4
4	M5	01	—
6	M5	01	02

## ● SSU Union straight 413



Tube size
4
6



# Dimensions (Standard Type) (mm)

## Elbow SC

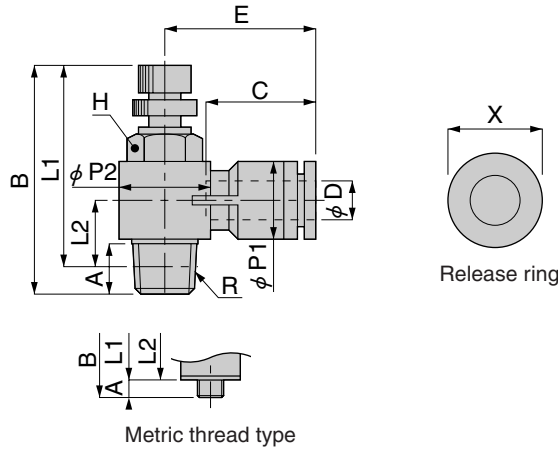

Model	Tube outer diameter $\phi$ D	R	A	B		L1 <sup>Note 1</sup>		L2 <sup>Note 1</sup>	$\phi$ P1	$\phi$ P2	C	E	Width across flats H	X	Mass (g) [oz.]
				MAX	MIN	MAX	MIN								
SC4-M5-□	4	M5×0.8	2.9	29.7	27	26.8	24.1	7.2	9.9	9.8	14.9	19.9	8	9.9	8.5 [0.300]
SC4-01-□		R1/8	8	40.7	34.4	36.7	30.4	9.7	10	14.4		21.4	10		18 [0.63]
SC6-M5-□	6	M5×0.8	2.9	29.7	27	26.8	24.1	8.4	12.4	9.8	17	24	8	11.8	9.6 [0.339]
SC6-01-□		R1/8	8	40.7	34.4	36.7	30.4	10.9		14.4		23.5	10		19 [0.67]
SC6-02-□		R1/4	11.1	47.8	41.4	41.8	35.4	12.2	18.4	25.5		14	36 [1.27]		
SC6-03-□		R3/8	13.2	53.7	46.5	47.3	40.1	15.4	14.4	22		29	19		65 [2.29]
SC8-01-□	8	R1/8	8	40.7	34.4	36.7	30.4	11.9	14.4	14.4	18.1	26.9	10	13.8	21 [0.74]
SC8-02-□		R1/4	11.1	47.8	41.4	41.8	35.4	13.2		18.4		28.4	14		38 [1.34]
SC8-03-□		R3/8	13.2	53.7	46.5	47.3	40.1	15.4		22		28.9	19		65 [2.29]
SC8-04-□		R1/2	16	59.3	52.3	51.1	44.1	18		28		31	24		101 [3.56]
SC10-02-□	10	R1/4	11.1	47.8	41.4	41.8	35.4	14.8	17.6	18.4	20.2	30.9	14	16.8	41 [1.45]
SC10-03-□		R3/8	13.2	53.7	46.5	47.3	40.1	16.7		22		31.2	19		69 [2.43]
SC10-04-□		R1/2	16	59.3	52.3	51.1	44.1	18		28		33.6	24		104 [3.67]
SC12-03-□	12	R3/8	13.2	53.7	46.5	47.3	40.1	18.4	21	22	23.4	36.9	19	19.8	72 [2.54]
SC12-04-□		R1/2	16	59.3	52.3	51.1	44.1	19.7		28		36.4	24		107 [3.77]

Notes : 1. The L1, L2 dimensions for the tapered thread type are the reference dimensions after the fittings are assembled.  
 2. In the blank box shown at the end of the model order code, enter **A** for meter-out control or **B** for meter-in control.

# Dimensions (Standard Type) (mm)

Straight  
SS

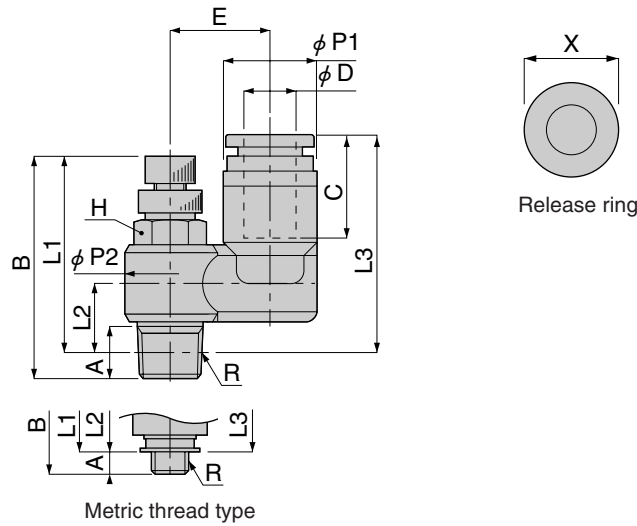

Model	Tube outer diameter $\phi D$	R	A	B		L1 <sup>Note 1</sup>		L2 <sup>Note 1</sup>	L3 <sup>Note 1</sup>	$\phi P1$	$\phi P2$	C	E	Width across flats H	X	Mass (g) [oz.]
				MAX	MIN	MAX	MIN									
SS4-M5-□	4	M5X0.8	2.9	29.7	27	26.8	24.1	6.8	23.9	10.2	9.8	14.9	10.5	8	9.9	9.1 [0.321]
SS4-01-□		R1/8	8	40.7	34.4	36.7	30.4	10.9	28.9		14.4		13	10		19 [0.67]
SS6-M5-□	6	M5X0.8	2.9	29.7	27	26.8	24.1	6.8	26	12.6	9.8	17	12.2	8	11.8	10 [0.35]
SS6-01-□		R1/8	8	40.7	34.4	36.7	30.4	10.9	31		14.4		14.2	10		21 [0.74]
SS6-02-□		R1/4	11.1	47.8	41.4	41.8	35.4	12	32.1		18.4		17.2	14		38 [1.34]
SS8-01-□	8	R1/8	8	40.7	34.4	36.7	30.4	10.9	32.4	14.6	14.4	18.1	15.2	10	13.8	22 [0.78]
SS8-02-□		R1/4	11.1	47.8	41.4	41.8	35.4	12	33.6		18.4		18.2	14		39 [1.38]
SS8-03-□		R3/8	13.2	53.7	46.5	47.3	40.1	15.4	37.8		22		19.2	19		68 [2.40]
SS10-02-□	10	R1/4	11.1	47.8	41.4	41.8	35.4	12	35.9	17.8	18.4	20.2	19.8	14	16.8	43 [1.52]
SS10-03-□		R3/8	13.2	53.7	46.5	47.3	40.1	15.4	40.1		22		20.8	19		71 [2.50]
SS12-03-□	12	R3/8	13.2	53.7	46.5	47.3	40.1	15.4	42.8	21.2	22	23.4	22.5	19	19.8	75 [2.65]
SS12-04-□		R1/2	16	59.3	52.3	51.1	44.1	18.2	47		28		25.5	24		112 [3.95]

Notes : 1. The L1, L2 and L3 dimensions for the tapered thread type are the reference dimensions after the fittings are assembled.  
2. In the blank box shown at the end of the model order code, enter **A** for meter-out control or **B** for meter-in control.

# Dimensions (Mini Type) (mm)

## Elbow SC



M3M, M5M



Taper thread

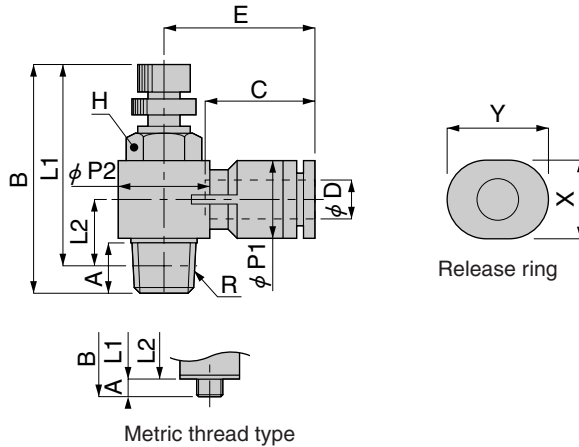

Model	Tube outer diameter $\phi D$	R	A	B		L1 <sup>Note 1</sup>		L2 <sup>Note 1</sup>	$\phi P1$	$\phi P2$	C	E	Width across flats H	X	Y	Mass (g) [oz.]			
				MAX	MIN	MAX	MIN												
SC3-M3-M <input type="checkbox"/>	3	M3X0.5	2.5	29.2	26.5	26.7	24	6.6	8	9.8	11	15.4	8	7.8	9.8	6.6 [0.233]			
SC3-M5-M <input type="checkbox"/>		M5X0.8	2.9	29.7	27	26.8	24.1	6.7								7.3 [0.257]			
SC4-M3-M <input type="checkbox"/>	4	M3X0.5	2.5	29.2	26.5	26.7	24	6.6	8	9.8	11	15.4	8	7.8	9.8	6.6 [0.233]			
SC4-M5-M <input type="checkbox"/>		M5X0.8	2.9	29.7	27	26.8	24.1	6.7								7.2 [0.254]			
SC4-01-M <input type="checkbox"/>		R1/8	8	40.7	34.4	36.7	30.4	10.7								14.4	17.7	10	17 [0.60]
SC6-M5-M <input type="checkbox"/>	6	M5X0.8	2.9	29.7	27	26.8	24.1	7.5	10.5	14.4	11.6	17.5	8	9.8	11.8	7.9 [0.279]			
SC6-01-M <input type="checkbox"/>		R1/8	8	40.7	34.4	36.7	30.4	10.7								14.4	18.3	10	18 [0.63]
SC6-02-M <input type="checkbox"/>		R1/4	11.1	47.8	41.4	41.8	35.4	11.9								18.4	20.2	14	35 [1.23]

Notes : 1. The L1, L2 dimensions for the tapered thread type are the reference dimensions after the fittings are assembled.  
 2. In the blank box shown at the end of the model order code, enter A for meter-out control or B for meter-in control.

## Straight SS



M3M, M5M



Taper thread

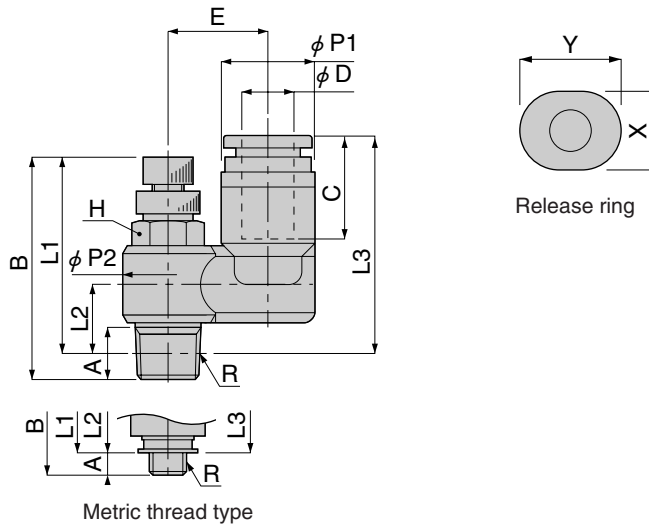

Model	Tube outer diameter $\phi D$	R	A	B		L1 <sup>Note 1</sup>		L2 <sup>Note 1</sup>	L3 <sup>Note 1</sup>	$\phi P1$	$\phi P2$	C	E	Width across flats H	X	Y	Mass (g) [oz.]
				MAX	MIN	MAX	MIN										
SS3-M3-M <input type="checkbox"/>	3	M3X0.5	2.5	29.2	26.5	26.7	24	6.7	21.2	8	9.8	11	9	8	7.8	9.8	7 [0.247]
SS3-M5-M <input type="checkbox"/>		M5X0.8	2.9	29.7	27	26.8	24.1	6.8	21.3								7.7 [0.272]
SS4-M3-M <input type="checkbox"/>	4	M3X0.5	2.5	29.2	26.5	26.7	24	6.7	21.2	8	9.8	11	9	8	7.8	9.8	7 [0.247]
SS4-M5-M <input type="checkbox"/>		M5X0.8	2.9	29.7	27	26.8	24.1	6.8	21.3								7.6 [0.268]
SS4-01-M <input type="checkbox"/>		R1/8	8	40.7	34.4	36.7	30.4	10.9	25.6								14.4
SS6-M5-M <input type="checkbox"/>	6	M5X0.8	2.9	29.7	27	26.8	24.1	6.8	22.2	10.5	14.4	11.6	10.9	8	9.8	11.8	8.4 [0.296]
SS6-01-M <input type="checkbox"/>		R1/8	8	40.7	34.4	36.7	30.4	10.9	26.5								12.8

Notes : 1. The L1, L2 and L3 dimensions for the tapered thread type are the reference dimensions after the fittings are assembled.  
 2. In the blank box shown at the end of the model order code, enter A for meter-out control or B for meter-in control.

## Dimensions (Union Straight Type) (mm)

### Union straight SSU

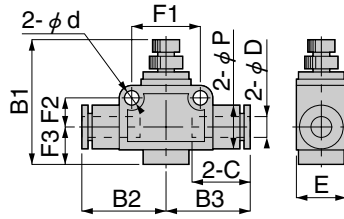

Model	Tube outer diameter $\phi D$	B1		B2	B3	$\phi P$	E	C	$\phi d$	F1	F2	F3	Mass (g) [oz.]
		MAX	MIN										
SSU4	4	28.6	25.9	20.4	20.4	10.5	11	14.9	3.2	14	6.5	6.5	13 [0.46]
SSU6	6	41.5	35.7	24.9	24.9	13	15	16.9	4.3	20	8.5	11	29 [1.02]
SSU8	8	46	39.8	27.4	27.4	15	18	18.4	4.3	22	9.5	12	43 [1.52]
SSU10	10	55.6	48	31.7	31.7	18	21	20.7	4.3	26	11	12	71 [2.50]
SSU12	12	55.9	48.4	37.2	37.2	21	28	23.4	4.3	32	13	16	115 [4.06]

## Dimensions (Large Flow Type) (mm)

### Elbow SCG

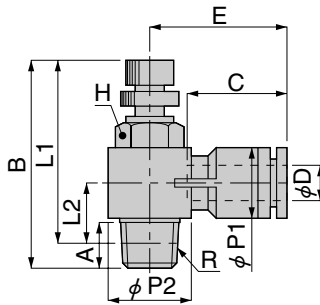

Model	Tube outer diameter $\phi D$	R	A	B		L1 <sup>Note</sup>		L2 <sup>Note</sup>	$\phi P1$	$\phi P2$	C	E	Width across flats H	Mass (g) [oz.]					
				MAX	MIN	MAX	MIN												
SCG6-01-A	6	R1/8	8.5	42.5	37.5	38.5	33.5	12.5	12.5	15.4	17	24.2	13	24 [0.85]					
SCG6-02-A		R1/4	11.6	50.8	44.8	44.8	38.8								14.1	19.6	26.8	17	43 [1.52]
SCG8-01-A	8	R1/8	8.5	42.5	37.5	38.5	33.5	14.5	14.5	15.4	18.1	26.2	13	26 [0.92]					
SCG8-02-A		R1/4	11.6	50.8	44.8	44.8	38.8								14.1	19.6	28.2	17	45 [1.59]
SCG8-03-A		R3/8	12.6	54.3	48.7	47.9	42.3								16.3	24.4	30.2	21	72 [2.54]
SCG10-02-A	10	R1/4	11.6	50.8	44.8	44.8	38.8	15.6	18	19.6	20.2	30.5	17	48 [1.69]					
SCG10-03-A		R3/8	12.6	54.3	48.7	47.9	42.3								16.3	24.4	32.5	21	75 [2.65]
SCG12-03-A	12	R3/8	12.6	54.3	48.7	47.9	42.3	17.8	21	24.4	23.4	35.2	21	78 [2.75]					
SCG12-04-A		R1/2	13.6	60.8	54.7	52.6	46.5								17.1	30	38.2	24	118 [4.16]

Note: The L1, L2 dimensions for the tapered thread type are the reference dimensions after the fittings are assembled.

## Dimensions (Low Pressure Type) (mm)

### Elbow SC□-□□L

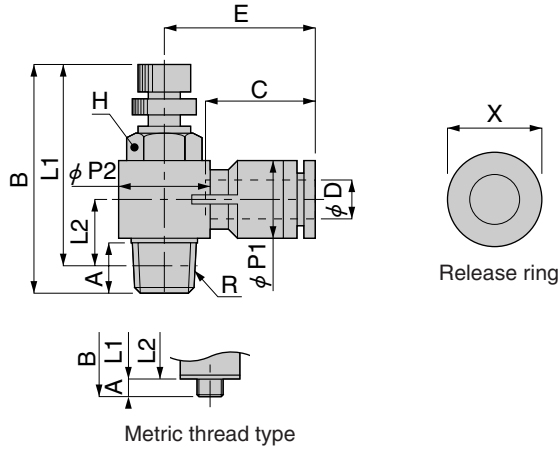

Model	Tube outer diameter $\phi$ D	R	A	B		L1 <sup>Note 1</sup>		L2 <sup>Note 1</sup>	$\phi$ P1	$\phi$ P2	C	E	H	X	Mass (g) [oz.]
				MAX	MIN	MAX	MIN								
SC4-M5-□L	4	M5X0.8	2.9	29.7	27	26.8	24.1	7.2	9.9	9.8	14.9	19.9	8	9.9	8.5 [0.300]
SC4-01-□L		R1/8	8	40.7	34.4	36.7	30.4	9.7	10	14.4		21.4	10		18 [0.63]
SC6-M5-□L	6	M5X0.8	2.9	29.7	27	26.8	24.1	8.4	12.4	9.8	17	24	8	11.8	9.6 [0.339]
SC6-01-□L		R1/8	8	40.7	34.4	36.7	30.4	10.9		14.4		23.5	10		19 [0.67]
SC6-02-□L		R1/4	11.1	47.8	41.4	41.8	35.4	12.2		18.4		25.5	14		36 [1.27]

Notes : 1. The L1, L2 dimensions for the tapered thread type are the reference dimensions after the fittings are assembled.  
2. In the blank box of the model order code, enter **A** for meter-out control or **B** for meter-in control.

### Straight SS□-□□L

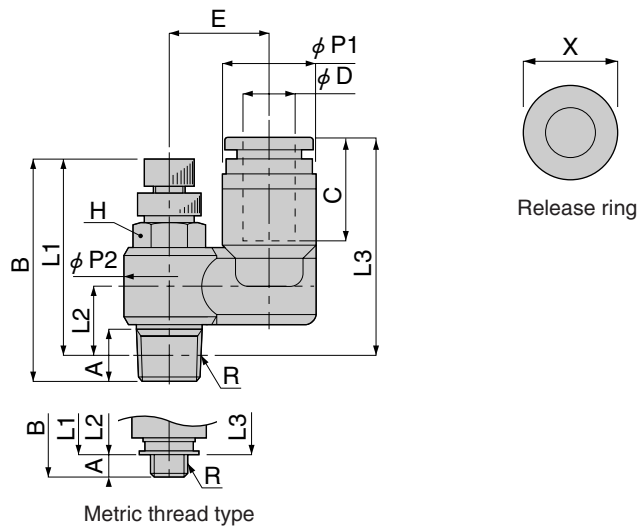

Model	Tube outer diameter $\phi$ D	R	A	B		L1 <sup>Note 1</sup>		L2 <sup>Note 1</sup>	L3 <sup>Note 1</sup>	$\phi$ P1	$\phi$ P2	C	E	H	X	Mass (g) [oz.]
				MAX	MIN	MAX	MIN									
SS4-M5-□L	4	M5X0.8	2.9	29.7	27	26.8	24.1	6.8	23.9	10.2	9.8	14.9	10.5	8	9.9	9.1 [0.321]
SS4-01-□L		R1/8	8	40.7	34.4	36.7	30.4	10.9	28.9		14.4		13	10		19 [0.67]
SS6-M5-□L	6	M5X0.8	2.9	29.7	27	26.8	24.1	6.8	26	12.6	9.8	17	12.2	8	11.8	10 [0.35]
SS6-01-□L		R1/8	8	40.7	34.4	36.7	30.4	10.9	31		14.4		14.2	10		21 [0.74]
SS6-02-□L		R1/4	11.1	47.8	41.4	41.8	35.4	12	32.1		18.4		17.2	14		38 [1.34]

Notes : 1. The L1, L2 and L3 dimensions for the tapered thread type are the reference dimensions after the fittings are assembled.  
2. In the blank box of the model order code, enter **A** for meter-out control or **B** for meter-in control.

## Dimensions (Low Pressure Type) (mm)

Union straight  
SSU□L

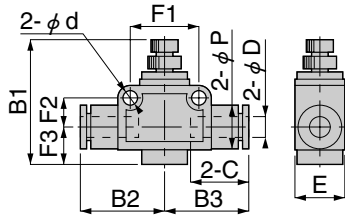

Model	Tube outer diameter $\phi D$	B1		B2	B3	$\phi P$	E	C	$\phi d$	F1	F2	F3	Mass (g) [oz.]
		MAX	MIN										
<b>SSU4L</b>	4	28.6	25.9	20.4	20.4	10.5	11	14.9	3.2	14	6.5	6.5	13 [0.46]
<b>SSU6L</b>	6	41.5	35.7	24.9	24.9	13	15	16.9	4.3	20	8.5	11	29 [1.02]

# Flow Rate Characteristics (Standard Type)

- SC4-M5-
- SC6-M5-
- SS4-M5-
- SS6-M5-

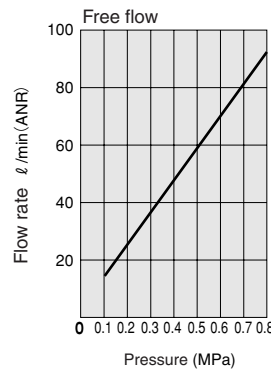
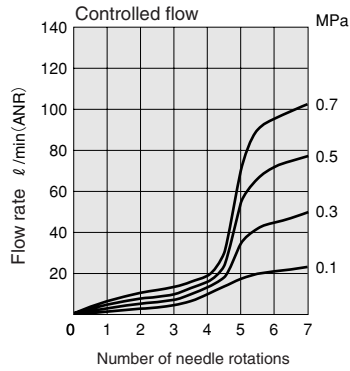

1MPa = 145psi.  
1 l/min = 0.0353ft<sup>3</sup>/min.

- SC4-01-
- SC6-01-
- SC8-01-
- SS4-01-
- SS6-01-
- SS8-01-

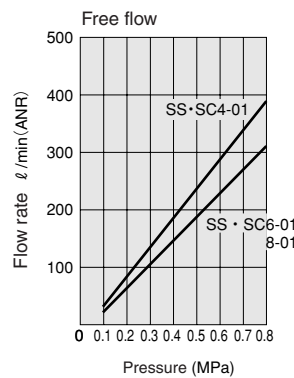
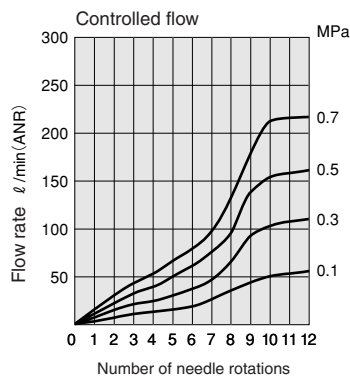

1MPa = 145psi.  
1 l/min = 0.0353ft<sup>3</sup>/min.

- SC6-02-
- SS6-02-

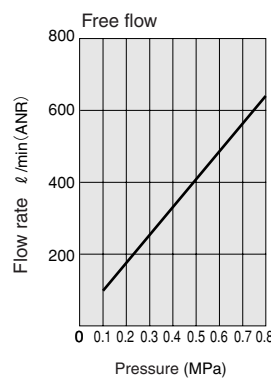
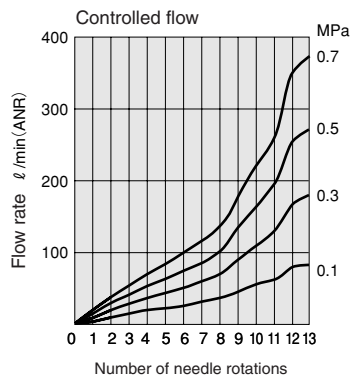

1MPa = 145psi.  
1 l/min = 0.0353ft<sup>3</sup>/min.

- SC8-02-
- SC10-02-
- SS8-02-
- SS10-02-

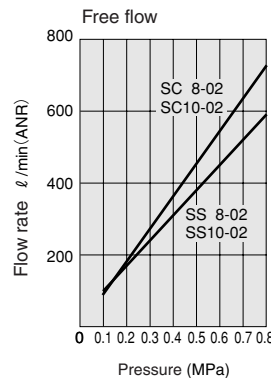
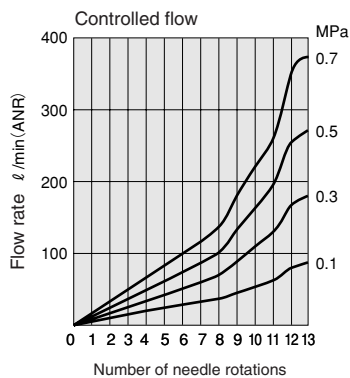

1MPa = 145psi.  
1 l/min = 0.0353ft<sup>3</sup>/min.

# Flow Rate Characteristics (Standard Type)

SC6-03-□

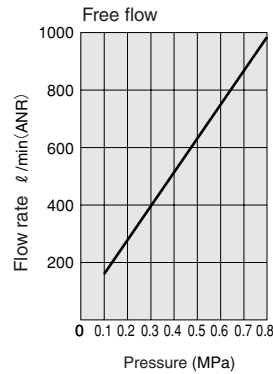
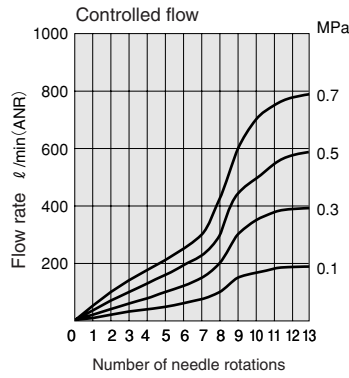

1MPa = 145psi.  
1  $\ell/\text{min}$  = 0.0353ft.<sup>3</sup>/min.

SC8-03-□

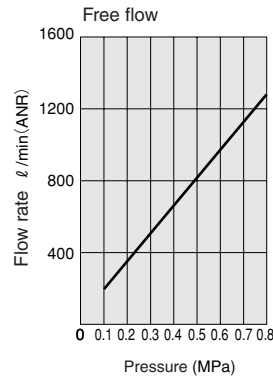
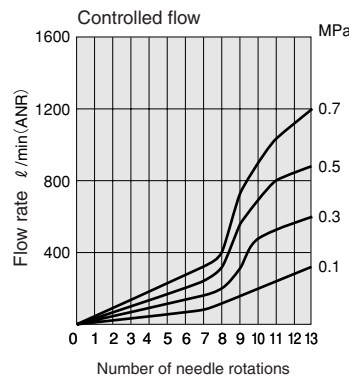

1MPa = 145psi.  
1  $\ell/\text{min}$  = 0.0353ft.<sup>3</sup>/min.

SC10-03-□

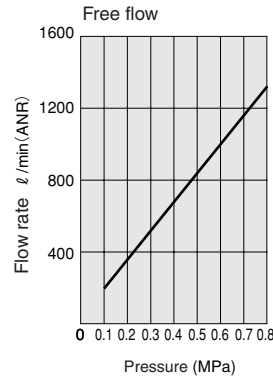
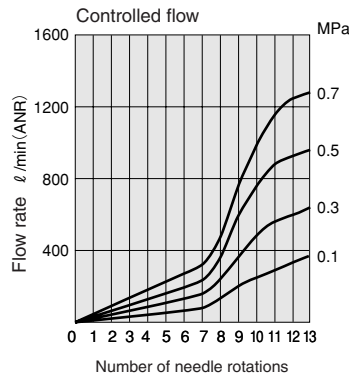

1MPa = 145psi.  
1  $\ell/\text{min}$  = 0.0353ft.<sup>3</sup>/min.

SS8-03-□

SS10-03-□

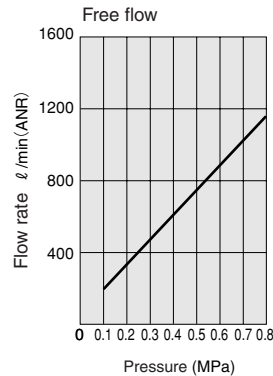
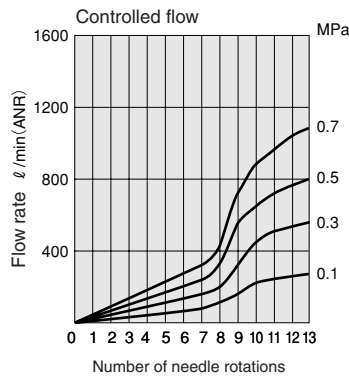

1MPa = 145psi.  
1  $\ell/\text{min}$  = 0.0353ft.<sup>3</sup>/min.



# Flow Rate Characteristics (Standard Type)

SC8-04-

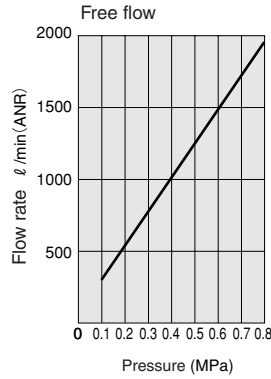
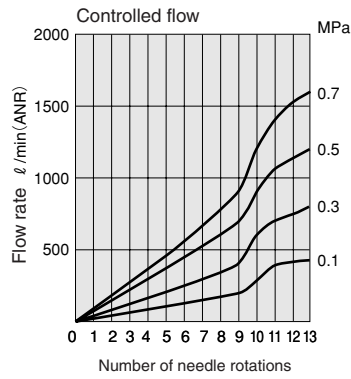

1MPa = 145psi.  
1  $\ell/\text{min}$  = 0.0353ft<sup>3</sup>/min.

SC12-03-

SS12-03-

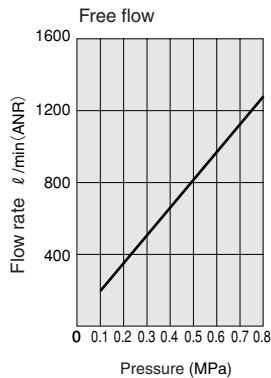
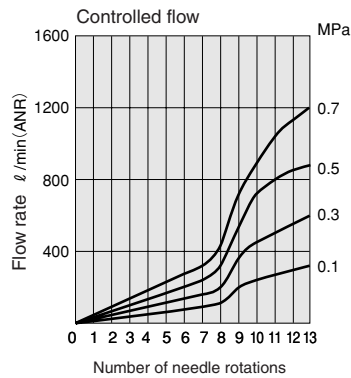

1MPa = 145psi.  
1  $\ell/\text{min}$  = 0.0353ft<sup>3</sup>/min.

SC10-04-

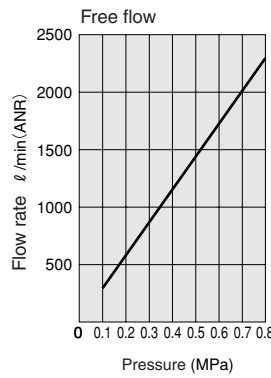
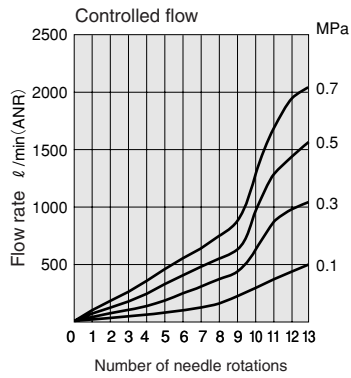

1MPa = 145psi.  
1  $\ell/\text{min}$  = 0.0353ft<sup>3</sup>/min.

SC12-04-

SS12-04-

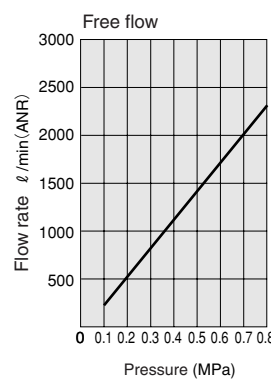
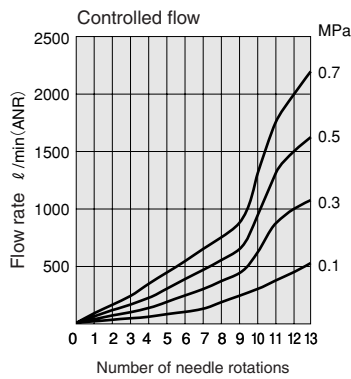

1MPa = 145psi.  
1  $\ell/\text{min}$  = 0.0353ft<sup>3</sup>/min.

# Flow Rate Characteristics (Mini Type)

SC3-M3-M   
 SS3-M3-M

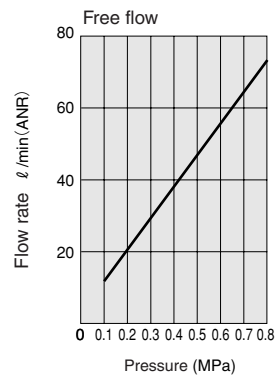
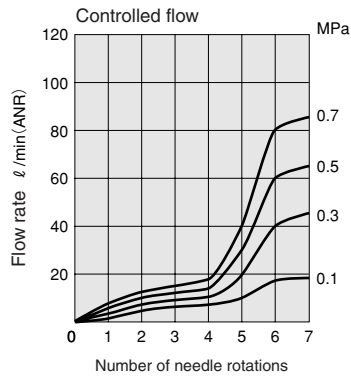

1MPa = 145psi.  
 1  $\ell/\text{min}$  = 0.0353ft<sup>3</sup>/min.

SC3-M5-M   
 SS3-M5-M

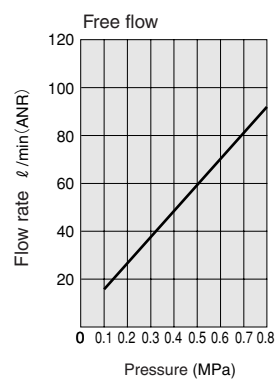
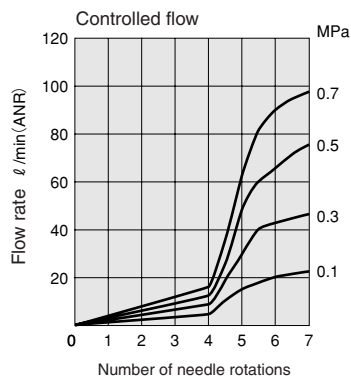

1MPa = 145psi.  
 1  $\ell/\text{min}$  = 0.0353ft<sup>3</sup>/min.

SC4-M3-M   
 SS4-M3-M

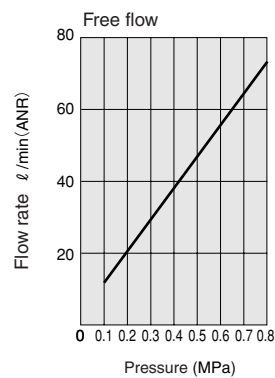
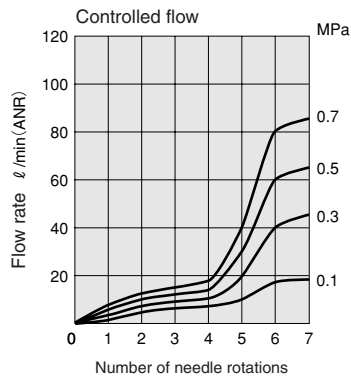

1MPa = 145psi.  
 1  $\ell/\text{min}$  = 0.0353ft<sup>3</sup>/min.

SC4-M5-M   
 SS4-M5-M

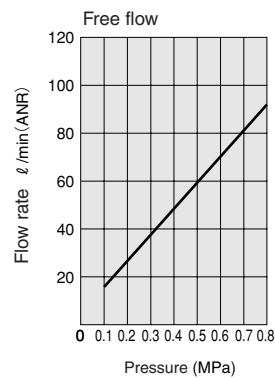
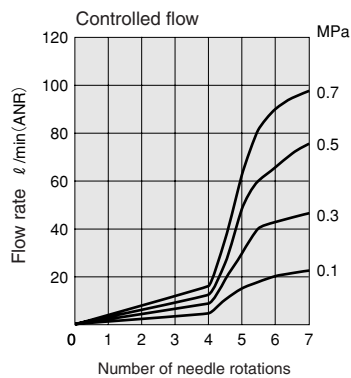

1MPa = 145psi.  
 1  $\ell/\text{min}$  = 0.0353ft<sup>3</sup>/min.

# Flow Rate Characteristics (Mini Type)

## SC4-01-M

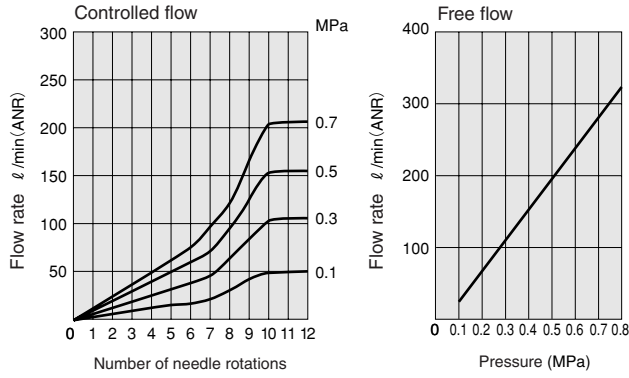

## SS4-01-M

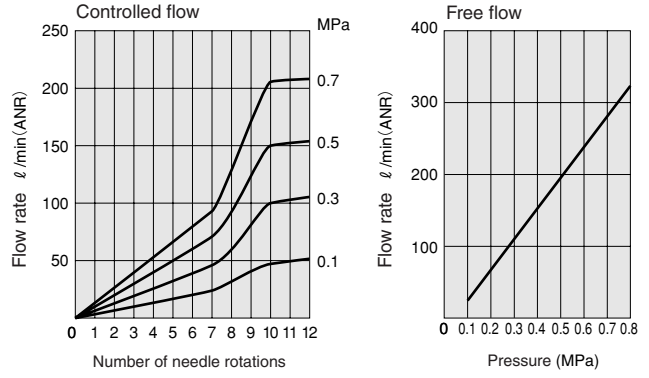

1MPa = 145psi. 1 l/min = 0.0353ft<sup>3</sup>/min.

## SC6-M5-M

## SS6-M5-M

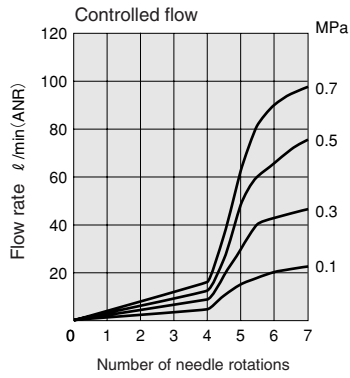

1MPa = 145psi.  
1 l/min = 0.0353ft<sup>3</sup>/min.

## SC6-01-M

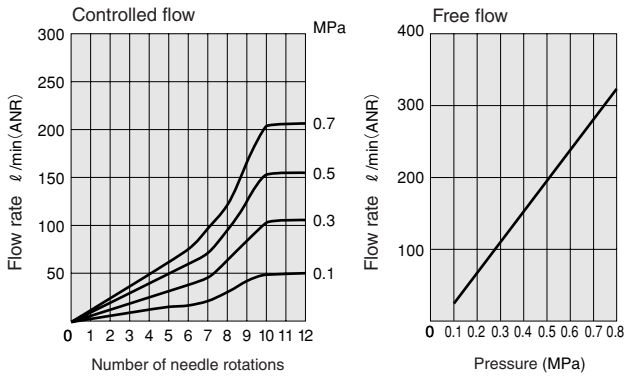

## SS6-01-M

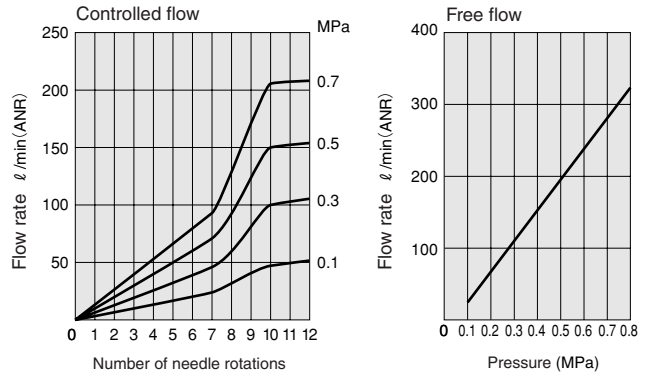

1MPa = 145psi. 1 l/min = 0.0353ft<sup>3</sup>/min.

## SC6-02-M

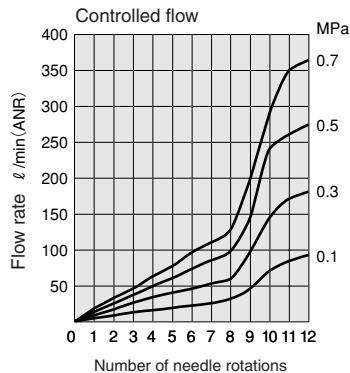

1MPa = 145psi.  
1 l/min = 0.0353ft<sup>3</sup>/min.

# Flow Rate Characteristics (Union Straight Type)

## SSU4

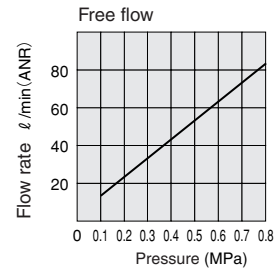
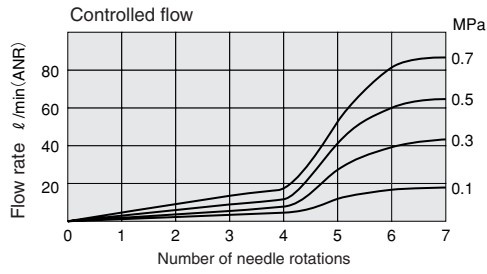

1MPa = 145psi.  
1  $\ell/\text{min}$  = 0.0353ft<sup>3</sup>/min.

## SSU6

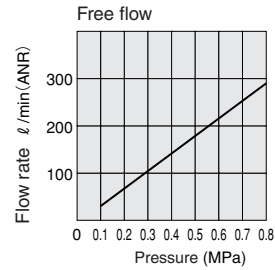
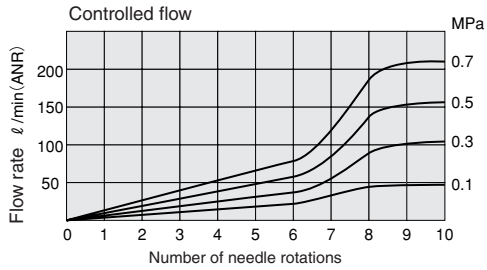

1MPa = 145psi.  
1  $\ell/\text{min}$  = 0.0353ft<sup>3</sup>/min.

## SSU8

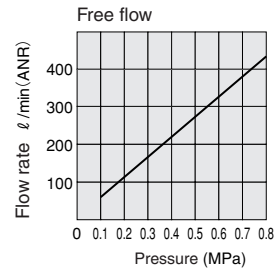
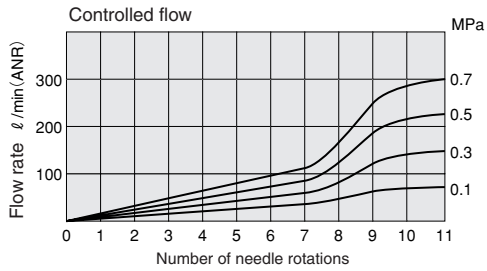

1MPa = 145psi.  
1  $\ell/\text{min}$  = 0.0353ft<sup>3</sup>/min.

## SSU10

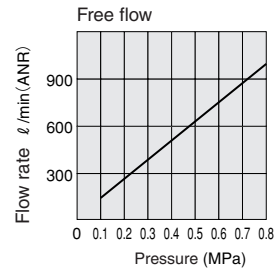
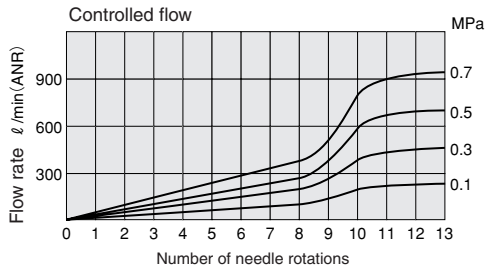

1MPa = 145psi.  
1  $\ell/\text{min}$  = 0.0353ft<sup>3</sup>/min.

## SSU12

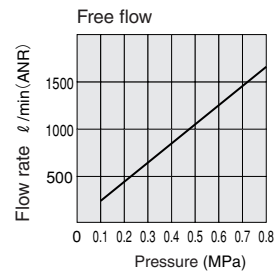
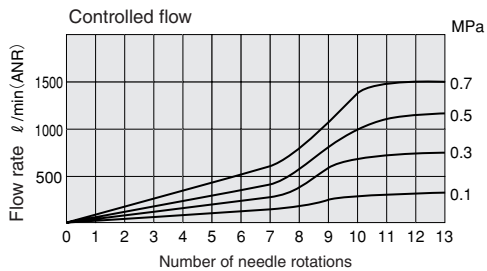

1MPa = 145psi.  
1  $\ell/\text{min}$  = 0.0353ft<sup>3</sup>/min.

# Flow Rate Characteristics (Large Flow Type)

**SCG6-01-A**  
**SCG8-01-A**

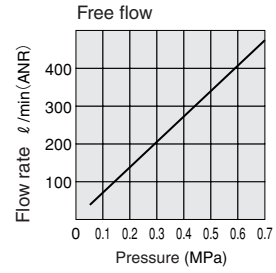
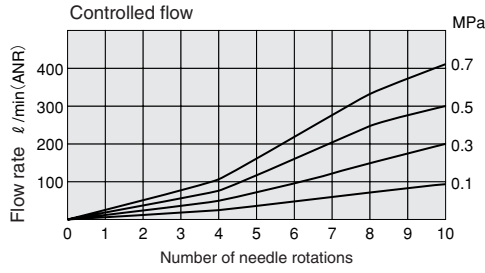

1 MPa = 145psi.  
1 l/min = 0.0353ft<sup>3</sup>/min.

**SCG6-02-A**

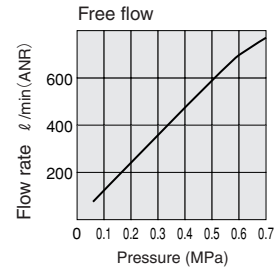
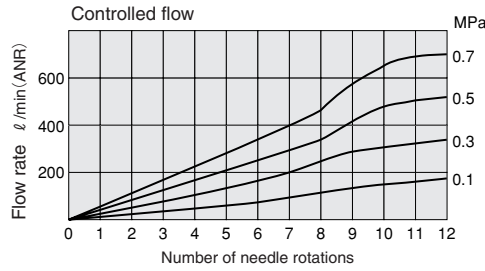

1 MPa = 145psi.  
1 l/min = 0.0353ft<sup>3</sup>/min.

**SCG8-02-A**  
**SCG10-02-A**

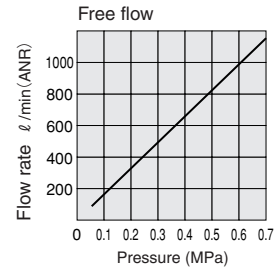
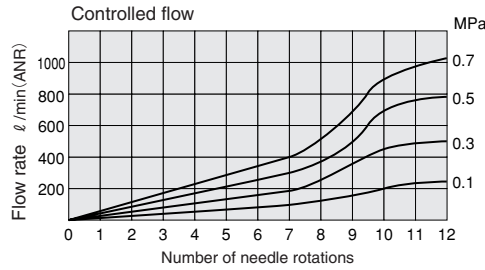

1 MPa = 145psi.  
1 l/min = 0.0353ft<sup>3</sup>/min.

**SCG8-03-A**

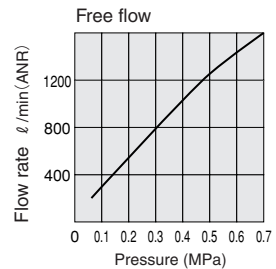
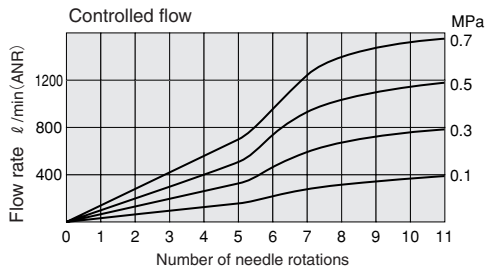

1 MPa = 145psi.  
1 l/min = 0.0353ft<sup>3</sup>/min.

**SCG10-03-A**  
**SCG12-03-A**

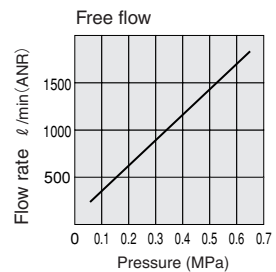
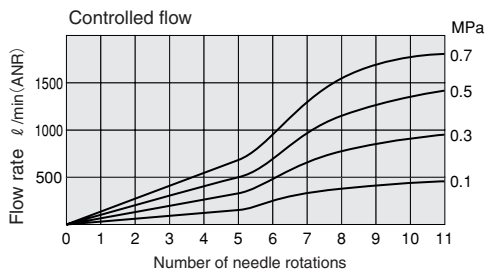

1 MPa = 145psi.  
1 l/min = 0.0353ft<sup>3</sup>/min.

**SCG12-04-A**

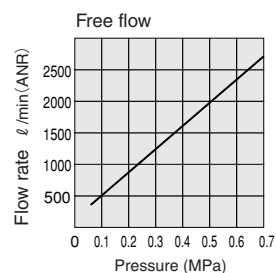
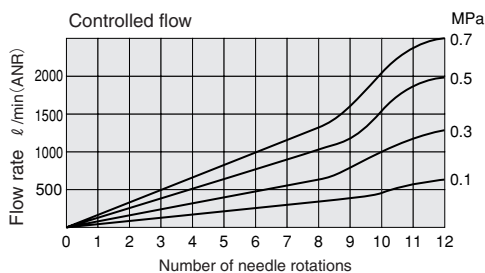

1 MPa = 145psi.  
1 l/min = 0.0353ft<sup>3</sup>/min.

# Flow Rate Characteristics (Low Pressure Type, Elbow/Straight)

SC4-M5-□L SC6-M5-□L  
 SS4-M5-□L SS6-M5-□L

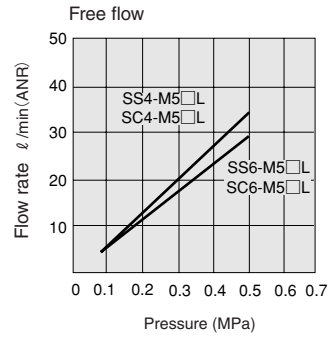
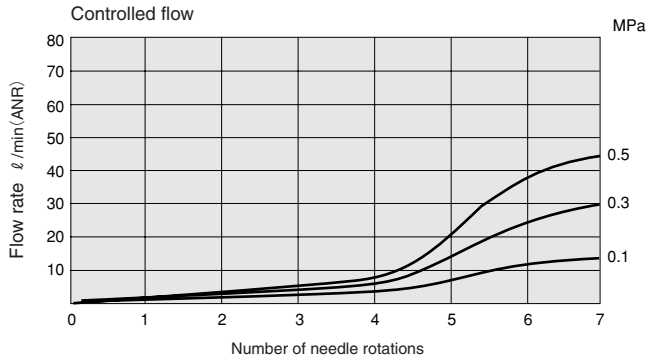

1MPa = 145psi. 1 l/min = 0.0353ft<sup>3</sup>/min.

SC4-01-□L SC6-01-□L  
 SS4-01-□L SS6-01-□L

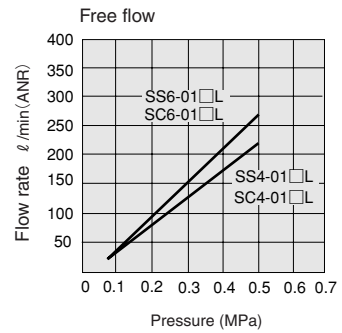
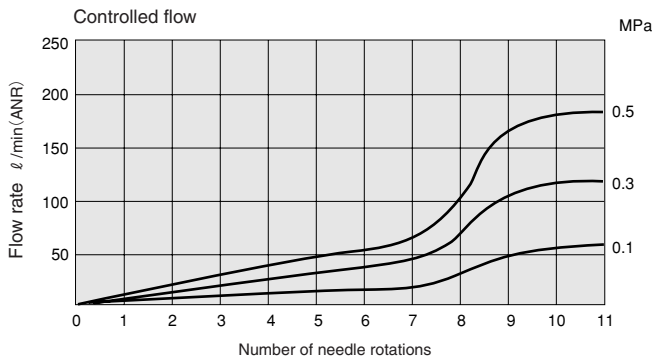

1MPa = 145psi. 1 l/min = 0.0353ft<sup>3</sup>/min.

SC6-02-□L SS6-02-□L

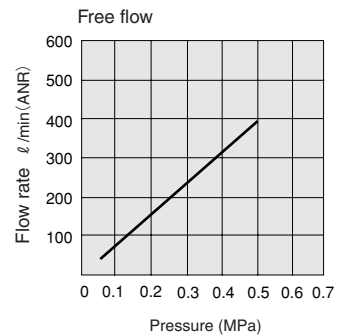
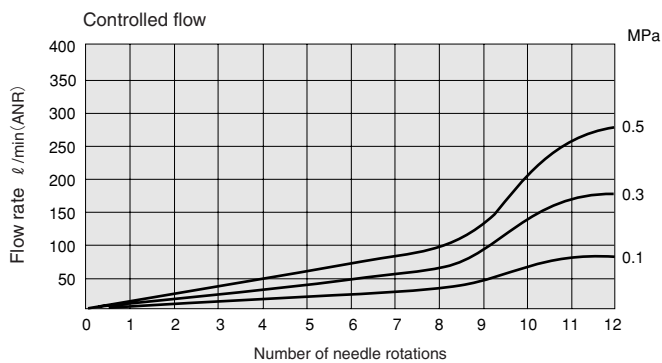

1MPa = 145psi. 1 l/min = 0.0353ft<sup>3</sup>/min.

# Flow Rate Characteristics (Low Pressure Type, Union Straight)

## SSU4L

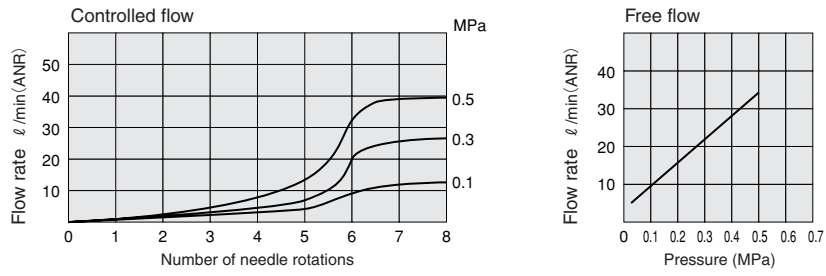

1MPa = 145psi. 1 l/min = 0.0353ft<sup>3</sup>/min.

## SSU6L

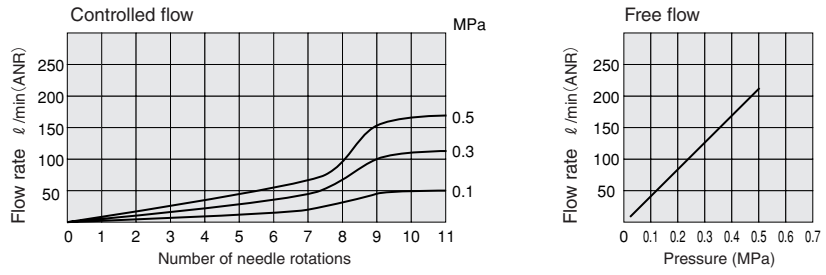

1MPa = 145psi. 1 l/min = 0.0353ft<sup>3</sup>/min.

SPEED CONTROLLERS WITH QUICK FITTINGS

# SPEED CONTROLLERS WITH QUICK FITTINGS

## NCU Specification

### NCU Specification

#### ● Order codes

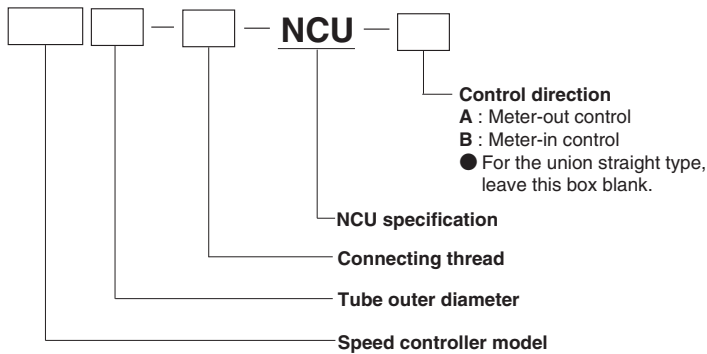

※For the fitting models, the tube size and thread combinations, see the table below. Columns showing the “←” symbol indicate that standard products can be used as the NCU specification. In these cases, place orders for the standard products.

- For specifications, see p.397, 404.
- The dimensions, inner construction, major parts and materials for the NCU specification shown below are the same as the standard type. See inner construction, major parts and materials on p.397, 404, and dimensions on p.399, 408~413. The sealant is not applied to the R taper thread portion of the NCU specification fittings.

**Caution:** For delivery, consult us.

#### ● Model Table (NCU Specification)

Type	Tube outer diameter	Thread	Standard type model (reference)	NCU specification model
Standard type elbow SC	4	M5×0.8	SC4-M5-A	←
			SC4-M5-B	←
		R1/8	SC4-01-A	SC4-01-NCU-A
			SC4-01-B	SC4-01-NCU-B
	6	M5×0.8	SC6-M5-A	←
			SC6-M5-B	←
		R1/8	SC6-01-A	SC6-01-NCU-A
			SC6-01-B	SC6-01-NCU-B
		R1/4	SC6-02-A	SC6-02-NCU-A
			SC6-02-B	SC6-02-NCU-B
		R3/8	SC6-03-A	SC6-03-NCU-A
			SC6-03-B	SC6-03-NCU-B
	8	R1/8	SC8-01-A	SC8-01-NCU-A
			SC8-01-B	SC8-01-NCU-B
		R1/4	SC8-02-A	SC8-02-NCU-A
			SC8-02-B	SC8-02-NCU-B
		R3/8	SC8-03-A	SC8-03-NCU-A
			SC8-03-B	SC8-03-NCU-B
		R1/2	SC8-04-A	SC8-04-NCU-A
			SC8-04-B	SC8-04-NCU-B
	10	R1/4	SC10-02-A	SC10-02-NCU-A
			SC10-02-B	SC10-02-NCU-B
		R3/8	SC10-03-A	SC10-03-NCU-A
			SC10-03-B	SC10-03-NCU-B
R1/2		SC10-04-A	SC10-04-NCU-A	
		SC10-04-B	SC10-04-NCU-B	
12	R3/8	SC12-03-A	SC12-03-NCU-A	
		SC12-03-B	SC12-03-NCU-B	
	R1/2	SC12-04-A	SC12-04-NCU-A	
		SC12-04-B	SC12-04-NCU-B	

Type	Tube outer diameter	Thread	Standard type model (reference)	NCU specification model
Standard type straight SS	4	M5×0.8	SS4-M5-A	←
			SS4-M5-B	←
		R1/8	SS4-01-A	SS4-01-NCU-A
			SS4-01-B	SS4-01-NCU-B
	6	M5×0.8	SS6-M5-A	←
			SS6-M5-B	←
		R1/8	SS6-01-A	SS6-01-NCU-A
			SS6-01-B	SS6-01-NCU-B
		R1/4	SS6-02-A	SS6-02-NCU-A
			SS6-02-B	SS6-02-NCU-B
	8	R1/8	SS8-01-A	SS8-01-NCU-A
			SS8-01-B	SS8-01-NCU-B
		R1/4	SS8-02-A	SS8-02-NCU-A
			SS8-02-B	SS8-02-NCU-B
		R3/8	SS8-03-A	SS8-03-NCU-A
			SS8-03-B	SS8-03-NCU-B
	10	R1/4	SS10-02-A	SS10-02-NCU-A
			SS10-02-B	SS10-02-NCU-B
		R3/8	SS10-03-A	SS10-03-NCU-A
			SS10-03-B	SS10-03-NCU-B
	12	R3/8	SS12-03-A	SS12-03-NCU-A
			SS12-03-B	SS12-03-NCU-B
		R1/2	SS12-04-A	SS12-04-NCU-A
			SS12-04-B	SS12-04-NCU-B



## ● Model Table (NCU Specification)

Type	Tube outer diameter	Thread	Standard type model (reference)	NCU specification model	
Free type <b>SSF</b>	4	M5×0.8	SSF4-M5-A	←	
			SSF4-M5-B	←	
		R1/8	SSF4-01-A	SSF4-01-NCU-A	
			SSF4-01-B	SSF4-01-NCU-B	
	6	M5×0.8	SSF6-M5-A	←	
			SSF6-M5-B	←	
		R1/8	SSF6-01-A	SSF6-01-NCU-A	
			SSF6-01-B	SSF6-01-NCU-B	
		R1/4	SSF6-02-A	SSF6-02-NCU-A	
			SSF6-02-B	SSF6-02-NCU-B	
	8	R1/8	SSF8-01-A	SSF8-01-NCU-A	
			SSF8-01-B	SSF8-01-NCU-B	
		R1/4	SSF8-02-A	SSF8-02-NCU-A	
			SSF8-02-B	SSF8-02-NCU-B	
		R3/8	SSF8-03-A	SSF8-03-NCU-A	
			SSF8-03-B	SSF8-03-NCU-B	
	10	R1/4	SSF10-02-A	SSF10-02-NCU-A	
			SSF10-02-B	SSF10-02-NCU-B	
		R3/8	SSF10-03-A	SSF10-03-NCU-A	
			SSF10-03-B	SSF10-03-NCU-B	
	12	R3/8	SSF12-03-A	SSF12-03-NCU-A	
			SSF12-03-B	SSF12-03-NCU-B	
		R1/2	SSF12-04-A	SSF12-04-NCU-A	
			SSF12-04-B	SSF12-04-NCU-B	
Horizontal free type <b>SSF</b>	4	M5×0.8	SSF4-M5-A-P	←	
Mini type elbow <b>SC</b>	3	M3×0.5	SC3-M3-MA	←	
			SC3-M3-MB	←	
		M5×0.8	SC3-M5-MA	←	
			SC3-M5-MB	←	
	4	M3×0.5	SC4-M3-MA	←	
			SC4-M3-MB	←	
		M5×0.8	SC4-M5-MA	←	
			SC4-M5-MB	←	
		R1/8	SC4-01-MA	SC4-01-NCU-MA	
			SC4-01-MB	SC4-01-NCU-MB	
	6	M5×0.8	SC6-M5-MA	←	
			SC6-M5-MB	←	
		R1/8	SC6-01-MA	SC6-01-NCU-MA	
			SC6-01-MB	SC6-01-NCU-MB	
		R1/4	SC6-02-MA	SC6-02-NCU-MA	
			SC6-02-MB	SC6-02-NCU-MB	
	Mini type straight <b>SS</b>	3	M3×0.5	SS3-M3-MA	←
				SS3-M3-MB	←
			M5×0.8	SS3-M5-MA	←
				SS3-M5-MB	←
		4	M3×0.5	SS4-M3-MA	←
				SS4-M3-MB	←
			M5×0.8	SS4-M5-MA	←
				SS4-M5-MB	←
R1/8			SS4-01-MA	SS4-01-NCU-MA	
			SS4-01-MB	SS4-01-NCU-MB	
6		M5×0.8	SS6-M5-MA	←	
			SS6-M5-MB	←	
		R1/8	SS6-01-MA	SS6-01-NCU-MA	
			SS6-01-MB	SS6-01-NCU-MB	

Type	Tube outer diameter	Thread	Standard type model (reference)	NCU specification model	
Union straight <b>SSU</b>	4	----	SSU4	←	
	6	----	SSU6	←	
	8	----	SSU8	←	
	10	----	SSU10	←	
Large flow type elbow <b>SCG</b>	6	R1/8	SCG6-01-A	SCG6-01-NCU-A	
		R1/4	SCG6-02-A	SCG6-02-NCU-A	
	8	R1/8	SCG8-01-A	SCG8-01-NCU-A	
		R1/4	SCG8-02-A	SCG8-02-NCU-A	
	10	R3/8	SCG8-03-A	SCG8-03-NCU-A	
		R1/4	SCG10-02-A	SCG10-02-NCU-A	
	12	R3/8	SCG10-03-A	SCG10-03-NCU-A	
		R3/8	SCG12-03-A	SCG12-03-NCU-A	
		R1/2	SCG12-04-A	SCG12-04-NCU-A	
		Low pressure type elbow <b>SC</b>	4	M5×0.8	SC4-M5-AL
	R1/8			SC4-M5-BL	←
	6		M5×0.8	SC6-M5-AL	←
SC6-M5-BL				←	
R1/8			SC6-01-AL	SC6-01-NCU-AL	
			SC6-01-BL	SC6-01-NCU-BL	
R1/4			SC6-02-AL	SC6-02-NCU-AL	
			SC6-02-BL	SC6-02-NCU-BL	
Low pressure type straight <b>SS</b>	4		M5×0.8	SS4-M5-AL	←
				SS4-M5-BL	←
			R1/8	SS4-01-AL	SS4-01-NCU-AL
				SS4-01-BL	SS4-01-NCU-BL
	6	M5×0.8	SS6-M5-AL	←	
			SS6-M5-BL	←	
		R1/8	SS6-01-AL	SS6-01-NCU-AL	
			SS6-01-BL	SS6-01-NCU-BL	
		R1/4	SS6-02-AL	SS6-02-NCU-AL	
			SS6-02-BL	SS6-02-NCU-BL	
	Free type low pressure <b>SSF</b>	4	M5×0.8	SSF4-M5-AL	←
				SSF4-M5-BL	←
R1/8			SSF4-01-AL	SSF4-01-NCU-AL	
			SSF4-01-BL	SSF4-01-NCU-BL	
6		M5×0.8	SSF6-M5-AL	←	
			SSF6-M5-BL	←	
		R1/8	SSF6-01-AL	SSF6-01-NCU-AL	
			SSF6-01-BL	SSF6-01-NCU-BL	
		R1/4	SSF6-02-AL	SSF6-02-NCU-AL	
			SSF6-02-BL	SSF6-02-NCU-BL	
8		R1/8	SSF8-01-AL	SSF8-01-NCU-AL	
			SSF8-01-BL	SSF8-01-NCU-BL	
	R1/4	SSF8-02-AL	SSF8-02-NCU-AL		
		SSF8-02-BL	SSF8-02-NCU-BL		
10	R1/4	SSF10-02-AL	SSF10-02-NCU-AL		
		SSF10-02-BL	SSF10-02-NCU-BL		
Horizontal free type for low pressure <b>SSF</b>	4	M5×0.8	SSF4-M5-AL-P	←	
Low pressure type union straight <b>SSU</b>	4	----	SSU4L	←	
	6	----	SSU6L	←	

SPEED CONTROLLERS WITH QUICK FITTINGS

## Safety Precautions (Speed Controllers with Quick Fittings)

The following is a safety precaution to Speed Controllers with Quick Fittings. For other safety precautions, be sure to read the precautions on p.49.

### Warning

- Since the air control direction depends on the product, be sure to check this guide, and identification mark of the body, for use. An error in control direction is dangerous, resulting in injury to persons and damage to equipment.
- When adjusting the actuator speed, begin adjustment with the body needle in a completely closed state and then steadily open it up. When the needle is open, there is a danger of the actuator rod's popping out. Note that the needle is rotated clockwise to close and counterclockwise to open.
- Do not force the product to rotate or swing even if the plastic body is rotatable. Such application could cause damage or leakage in the body.
- Do not use a mechanical tool to tighten the product's lock nut, instead, manually tighten to firmly secure the lock nut in place. Using a mechanical tool to tighten could result in damage to the lock nut or the body. Also, if the lock nut is not firmly tightened, it could become loose, causing the initial setting to change.

## Handling Instructions and Precautions

### Mounting

#### Precautions for mounting the body

1. To mount the body, use a suitable tool to tighten it to the outer hexagonal section of the body.
2. When attaching fittings, tighten to the recommended tightening torque shown in the table below. Tightening to more than the recommended torque could result in broken threads or air leaks due to deformed gaskets. Tightening to less than the recommended torque could lead to loose screws or air leaks.

#### Recommended tightening torque

Thread type	Thread size	Tightening torque
Metric thread	M3×0.5	0.7N·m [6.2in·lbf]
	M5×0.8	1.5~1.9N·m [13.3~16.8in·lbf]
	M6×1	2~2.7N·m [17.7~23.9in·lbf]
Taper pipe thread	R1/8	7~9N·m [62~80in·lbf]
	R1/4	12~14N·m [106~124in·lbf]
	R3/8	22~24N·m [195~212in·lbf]
	R1/2	28~30N·m [248~266in·lbf]

#### Precautions for removing the body

1. To remove the body, use a suitable tool to loosen it from the outer hexagonal section of the body.
2. Clean off the sealant coating on the thread of the removed mating part. The coated sealant could enter other relating parts, and cause breakdowns.

### Caution

- The speed controller allows a certain amount of leakage. Do not use for situations where zero leakage volume are required.

#### Method for tightening screws

1. Tightening screws  
For tightening screws, use a wrench on outer hexagonal section.

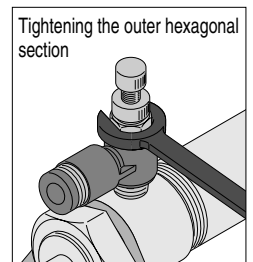

**Caution:** While the quick fitting sealant can be reused a number of times, the thread on the mating part may also be adhered with sealant. Always clean out the inside of the equipment's female thread.

#### Tube connection and disconnection

##### Precautions for connecting the tube

1. Check that the cut section of the tube has been cut at straight angle, that the outer surface of the tube is not scratched, and that the tube has not become oval shaped.
2. When connecting a tube, failure to insert the tube all the way to the end could result in air leaks.

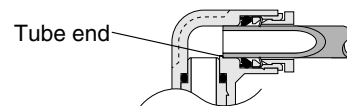

3. After connection, pull the tube to check that it will not disconnect.

##### Precautions for disconnecting the tube

1. Before disconnecting a tube, check that the pressure inside the tube is down to zero.
2. Push the release ring evenly all the way to the end, and then pull the tube out. An insufficient push could make it impossible to pull the tube out, or could scratch the tube, leaving scratched tube material inside the fitting.

# Handling Instructions and Precautions

## Tube connection and disconnection method

### 1. Tube connection

The Speed Controller with Quick Fitting is equipped with a lock claw that holds the tube in place when it has been pushed all the way to the end, and with an elastic sleeve for sealing the tube periphery.

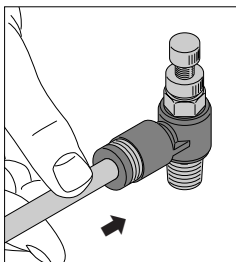

### 2. Tube disconnection

To disconnect the tube, first push on the release ring, releasing the lock claw, and then pull the tube out. Always stop the air supply before removing the tube.

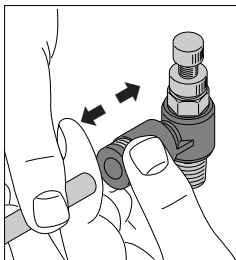

For cases where tight or cramped piping spaces hinder tube removal operations, a special tool is available. Consult us for details.

### Special tool for tube removal

For  $\phi$  3 [0.118in.],  $\phi$  4 [0.157in.] and  $\phi$  6 [0.236in.] tubes  
Order code : **UJ-1**



For  $\phi$  6 [0.236in.],  $\phi$  8 [0.315in.],  
 $\phi$  10 [0.394in.] and  $\phi$  12 [0.472in.] tubes  
Order code : **UJ-2**



## ● Usable tubes

Either nylon or urethane tubes can be used. The tube outer diameter accuracy should be, for nylon tubes, within  $\pm 0.1\text{mm}$  [ $\pm 0.004\text{in.}$ ] of the nominal dimensions, and for urethane tubes, within  $\pm 0.15\text{mm}$  [ $\pm 0.006\text{in.}$ ] of the nominal dimensions, while the ovalness (difference between long diameter and short diameter) should be within  $0.2\text{mm}$  [ $0.008\text{in.}$ ].

**Cautions:** 1. Use tubes with no visible scratches on the outer surface. If a scratch is made during repeated use, cut off the scratched portion.

2. Do not bend or twist the tube too much near the connection to the fitting. It could result in air leaks. The minimum bending radius for nylon tubes is as shown in the table below.

Tube size	Minimum bending radius
$\phi$ 3 [0.118]	18 [0.7]
$\phi$ 4 [0.157]	20 [0.8]
$\phi$ 6 [0.236]	30 [1.2]
$\phi$ 8 [0.315]	50 [2.0]
$\phi$ 10 [0.394]	80 [3.2]
$\phi$ 12 [0.472]	150 [5.9]

mm [in.]

## ● Speed adjustment of actuator

### 1. To increase the speed

From a completely closed position, rotate the speed controller needle in the counterclockwise direction to increase the speed of the actuator. When the desired speed has been reached, always tighten the lock nut to ensure that the speed setting does not change.

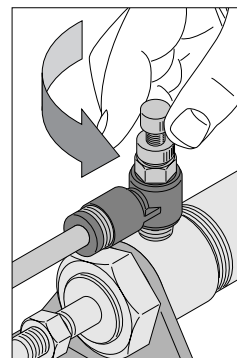

### 2. To reduce the speed

If the speed controller needle has been rotated too far (the speed is now too fast), rotate it in the clockwise direction to reduce the speed. When the desired speed has been reached, always tighten the lock nut to ensure that the speed setting does not change.

